

Plastic tubing, standard O.D.

FESTO



Festo Core Range
Solves the majority of your automation tasks

With the Festo Core Range, we have selected the most important products and functions from our broad product catalogue, and added the quickest delivery.

Worldwide: Quickest delivery – wherever, whenever
Simply good: Expected high Festo quality
Fast: Easy and fast to select

The Core Range offers you the best value for your automation tasks.

Just look
for the
star!

Key features

Application



The requirements for pressure, temperature, flexibility and environmental influences differ from one industry sector to the next. Users frequently underestimate the risks, since around 90% of all cases of damage can be traced back to the wrong choice of tubing or tubing materials. This can not only result in energy losses, but also machine downtimes. It is therefore really important to find a reliable and cost-effective product that prevents the tubing from getting damaged during operation.

Overview of tubing/fitting combinations

Applications	Tubing	Fitting	Description
Standard	PUN-H	QS	Maximum flexibility in standard applications thanks to an extremely wide range of options for combining the different types.
	PAN	QS	Meets all requirements, even for standard applications with increased pressure and temperature ranges.
	PEN	QS	Suitable for a wide range of tasks and attractively priced. Flexible thanks to highly resistant materials, easy to install thanks to optimised bending radii. High level of abrasion resistance in dynamic applications.
High pressures	PAN-MF	NPQM	Meets DIN standard 73378: ideal for use in mobile pneumatics. Suitable for increased temperature ranges combined with high pressure ranges.
	PAN-R	NPQH	Powerful in pressure ranges up to 20 bar, for example in applications with the pressure booster DPA.
Resistant to chemicals, food-safe and hydrolysis-resistant	PLN	NPQP	Resistant to cleaning agents, FDA-compliant and economical. Can be used instead of the combination with stainless steel fittings.
	PUN-H	NPKA	Hydrolysis-resistant and suitable for water applications. Combination suitable for use in cleanrooms, FDA-compliant and corrosion-resistant because it's 100% polymer. Very easy to install with the "one click principle".
	PUN-H-F	NPKA	Hydrolysis-resistant and suitable for water applications. Combination suitable for use in cleanrooms, FDA-compliant and corrosion-resistant because it's 100% polymer. Very easy to install with the "one click principle". Suitable for contact with food.
	PFAN/PTFEN	NPQH	For high temperatures up to 150°C. Food-safe, FDA-compliant and resistant to cleaning agents.
	PFAN/PTFEN	NPCK	Easy to clean thanks to the union nut's edge-free design. Maximum corrosion resistance (CRC 4) and FDA-compliant. Suitable for a wide range of media.
	PFAN/PTFEN	CRQS	Maximum corrosion resistance (CRC 4) and maximum resistance to aggressive acids and alkalis.
Resistant to chemicals and hydrolysis	PFAN/PTFEN	NPQR	Optimised design, fewer edges where dirt can collect – all at an attractive price. For high temperatures up to 150°C. Pressure range up to 16 bar. Highest level of corrosion resistance (CRC 4).
Antistatic	PUN-CM	NPQM	Antistatic tubing plus solid metal fitting: maximum protection for electrical and electronic components.
Flame-retardant	PUN-VO	NPQM	Very safe in areas where there is a risk of fire thanks to its flame-retardant properties.
Resistant to welding spatter	PUN-VO-C	NPQH	Ideal for applications with welding spatter. Reliable thanks to a tubing wall thickness of 2 mm for all diameters.
	PAN-VO	QS-VO	Safe even in the immediate vicinity of welding spatter thanks to the double-walled tubing with special fitting.

Note

Ambient conditions and the medium to be transported can have a considerable effect on the service life of plastic tubing. Based on experience, Festo recommends the following service life specifications for using plastic tubing in general and for safety-related applications:

- For general applications, a minimum service life of 10 years can be expected.
- For safety-related applications, we recommend regular inspection at least every 12 months.
- For applications that have an effect on the material, inspections must be carried out at suitable intervals. We recommend that the interval between inspections should be no more than 6 months, or at most half of the period in which failures can occur.

Technical data

Note

Tubing diameters that are too big or too small as well as bending radii that are too small result in flow rate losses. One of the most important rules when selecting tubing is therefore that it should be as long as necessary and as short as possible. Make sure therefore that in practice tubing is loosely installed and is not stretched.

Tools for bundling tubing or for avoiding bending/pinching the tubing are available as accessories:

- Tubing strap PB
- Spiral tubing binder PKB
- Tubing support NPAW
- Tubing support PKS
- Multi-tube holder KK

Other accessories include connecting tools for tubing:

- Pipe and tubing cutter ZRS
- Tubing cutter PAN-VOS for flame-retardant plastic tubing PAN-VO
- Connecting pliers ZMS/disconnecting pliers ZDS for connecting/disconnecting the plastic tubing and barbed fitting

Suitability for contact with food



Tubing PFAN and PUN-H-F are suitable for contact with food. They have the necessary declaration of conformity in accordance with EU Regulation (EC) No. 1935/2004.

Measurement method

Flow-relevant bending radius R_d

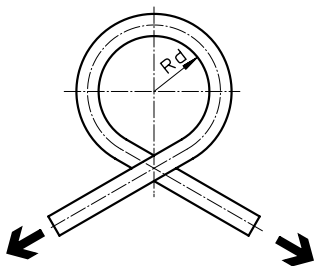

The tube is bent in the direction of its own curve until the tubing outer diameter is flattened by 5%. R_d is then calculated mathematically. The flow rate is not reduced until R_d is reached.

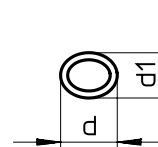

Cross section flattened by bending the tube.

- d = non-deformed tubing O.D.
- d_1 = deformed tubing O.D.

Minimum bending radius R_{min}

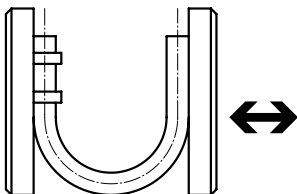

The tubing, which is fixed to the base plate, is bent until the deformation results in a kink. The measured value is the minimum bending radius R_{min} . This R_{min} results in significant reductions in flow rate.

Product range overview

Type	Material	O.D. [mm]	Colour														
			Silver	Blue	Translucent blue	Black	Translucent black	Yellow	Translucent yellow	Green	Translucent green	Red	Translucent red	Brown	White	Natural	Blue/black
PAN	Polyamide	4, 6, 8, 10, 12, 14, 16	■	■	-	■	-	■	-	■	-	■	-	(■) ¹⁾	(■) ¹⁾	■	-
PAN-R	Polyamide	4, 6, 8, 10, 12, (14) ¹⁾ , 16	■	(■) ¹⁾	-	(■) ¹⁾	-	(■) ¹⁾	-	(■) ¹⁾	-	(■) ¹⁾	-	(■) ¹⁾	(■) ¹⁾	(■) ¹⁾	-
		22, 28	-	-	-	■	-	-	-	-	-	-	-	-	-	-	-
PAN-MF	Polyamide	4, 6, 8, 10, 12, 14, 16	(■) ¹⁾	(■) ¹⁾	-	■	-	(■) ¹⁾	-	(■) ¹⁾	-	(■) ¹⁾	-	(■) ¹⁾	(■) ¹⁾	(■) ¹⁾	-
PAN-VO	Polyamide	4, 6, 8, 10, 12	-	■	-	■	-	■	-	■	-	■	-	-	■	-	-
PFAN	Perfluoroalkoxy alkane	3, 4, 6, 8, 10, 12	-	-	-	-	-	-	-	-	-	-	-	-	-	■	-
PTFEN	Polytetrafluoroethylene	4, 6, 8, 10, 12, 14, 16	-	-	-	-	-	-	-	-	-	-	-	-	-	■	-
PEN	Polyethylene	4, 6, 8, 10, 12, 14, 16	■	■	-	■	-	■	-	■	-	■	-	(■) ¹⁾	(■) ¹⁾	■	-
PLN	Polyethylene	4, 6, 8, 10, 12, 14, 16	■	■	-	■	-	(■) ¹⁾	-	(■) ¹⁾	-	■	-	(■) ¹⁾	(■) ¹⁾	■	-
PUN	Polyurethane	3, 4, 6, 8, 10, 12, 14, 16	■	■	-	■	-	■	-	■	-	■	-	(■) ¹⁾	(■) ¹⁾	-	-
PUN-DUO	Polyurethane	4, 6, 8, 10	■	-	-	-	-	-	-	-	-	-	-	-	-	-	■
PUN-CM	Polyurethane	4, 6, 8, 10, 12, (14) ¹⁾	-	-	-	■	-	-	-	-	-	-	-	-	-	-	-
PUN-H	Polyurethane	2	-	-	-	■	-	-	-	-	-	■	-	-	-	■	-
		3, 4, 6, 8, 10, 12, 14, 16	■	■	■	■	■	■	■	■	■	■	■	■	(■) ¹⁾	(■) ¹⁾	■
PUN-H-DUO	Polyurethane	4, 6, 8, 10	-	-	-	-	-	-	-	-	-	-	-	-	-	-	■
PUN-H-F	Polyurethane	4, 6, 8, 10, 12, 16	-	■	■	■	-	■	-	■	-	■	-	-	-	■	-
		14	-	■	-	■	-	-	-	-	-	■	-	-	-	■	-
PUN-VO	Polyurethane	6, 8, 10, 16	-	■	-	■	-	■	-	■	-	■	-	■	■	-	-
PUN-VO-C	Polyurethane	4, 6, 8, 10, 12, 14, 16	-	■	-	■	-	■	-	■	-	■	-	■	■	-	-

1) Please observe the note below.

 Note

Product options in brackets can only be ordered using the modular product system.

Please note the minimum ordering quantity of 3000 m for tubing with O.D. ≤ 8 mm and 1500 m with O.D. > 8 mm.

There is a modular product system for plastic tubing:

- PAN → page 16
- PEN → page 24
- PLN → page 27
- PUN → page 49

Product range overview

Type	Operating medium				Food-safe ⁹⁾	Food-safe ¹⁰⁾	Material fire test	Antistatic	Halogen-free	Contact with electric cables	Suitable for use with energy chains	Approved by the German Technical Control Board (TÜV)	Maritime classification	Resistance				Flexible	Shore hardness ⁸⁾	Tolerance for packaging length	→ Page/Internet
	Compressed air, vacuum	Water	Mineral oil	Oxygen										Chemicals	Microbes	UV radiation	Hydrolysis				
PAN	■	-	-	-	-	-	-	■	■	■	■	■ ³⁾	+	++	+	++	++	D 55 ±3	±1%	7	
PAN-R	■	-	-	-	-	-	-	■	■	■	■	-	+	++	+	++	+	D 62 ±3		10	
	■	-	-	-	-	-	-	■	■	■	-	-	+	++	+	++	+	D 62 ±3		11	
PAN-MF	■	-	■ ²⁾	-	-	-	-	■	■	■	-	-	+	++	+	++	+	D 65 ±3		12	
PAN-V0	■	■	■	-	-		UL94 V0	-	-	■	■	-	+	++	++	++	++	A 72 ±4 ⁵⁾ D 57 ±3 ⁶⁾		14	
PFAN	■	■	-	-	■	■	UL94 V0	-	-	■	-	■	+++	++	++	+++	+	D 60 +5		17	
PTFEN	■	-	-	-	■		UL94 V0	-	-	■	-	-	+++	++	++	+++	+	D 55 ±5		19	
PEN	■	■	-	-	-	-	-	-	■	■	■	■	-	++	++	+++ ⁴⁾	+++	++		D 52 ±3	21
PLN	■	■	-	-	■	-	-	-	■	■	-	■	-	++	++	+++ ⁴⁾	+++	+		D 59 ±3	25
PUN	■	-	-	-	-	-	UL94 HB	-	■	■ ⁷⁾	■	■	-	-	-	+++ ⁴⁾	+	+++		D 52 ±3	28
PUN-DUO	■	-	-	-	-	-	UL94 HB	-	■	■ ⁷⁾	■	■	-	-	-	+	+	++		D 52 ±3	31
PUN-CM	■	-	-	-	-	-	-	■	■	■	■	-	-	+	++	++	++	++		D 52 ±3	33
PUN-H	■	-	-	-	-	-	-	-	■	■	■	-	-	+	++	+++ ⁴⁾	++	+++		D 52 ±3	35
	■	■	-	-	■		UL94 HB	-	■	■	■	■	-	+	++	+++ ⁴⁾	++	+++		D 52 ±3	36
PUN-H-DUO	■	■	-	-	■		UL94 HB	-	■	■	■	■	-	+	++	+	++	++		D 52 ±3	41
PUN-H-F	■	■	-	■	-	■	UL94 HB	-	■	■	■	■	-	+	++	+++ ⁴⁾	++	++	D 52 ±3	43	
	■	■	-	■	-	■	UL94 HB	-	■	■	■	■	-	+	++	+++ ⁴⁾	++	++	D 52 ±3		
PUN-V0	■	■	-	-	-		UL94 V0...V2	-	■	■	■	■	-	+	++	+++ ⁴⁾	++	++	D 54 ±3	45	
PUN-V0-C	■	■	-	-	-		UL94 V0...V2	-	■	■	■	■	-	+	++	+++ ⁴⁾	++	++	D 54 ±3	47	

2) As a precaution, please check the operating medium with Festo.

3) Applies to the colours silver and natural

4) Applies to the colour black

5) Outside tubing

6) Inside tubing

7) Cables containing organophosphates may damage PUN tubing under unfavourable conditions.

8) Values are determined using test boards. Values that have been determined using tubing may vary.

9) See the supplementary material information

10) See declaration of conformity

■ Criterion met

- Not suitable

+++ Highly suitable

++ Suitable

+ Limited suitability (on request)

Recommended tubing/fitting combinations

Fitting	Tubing type															
	PAN	PAN-R	PAN-MF	PAN-VO	PEN	PLN	PAN	PTEN	PUN	PUN-DUO	PUN-CM	PUN-H	PUN-H-DUO	PUN-H-F	PUN-VO	PUN-VO-C
Fitting CK¹⁾	++	-	-	-	++	++	++	++	++	++	+	++	++	++	++	-
Fitting CN²⁾	++	-	-	-	++	+	++	++	++	++	+	-	-	-	+	-
Fitting QS³⁾	+++	++	++	+	+++	++	++	++	+++	+++	+	+++	+++	++	+	+
Fitting NPQH⁴⁾	++	+++	++	+	++	++	+++	+++	++	++	++	+++	+++	+++	++	+++
Fitting CRQS⁵⁾	++	++	++	+	++	++	+++	+++	++	++	+	++	++	+++	++	++
Fitting NPQP⁶⁾	++	++	++	+	++	+++	+++	+++	++	++	+	++	++	+++	+	+
Fitting NPKA⁷⁾	++	++	-	-	++	++	++	++	++	++	+	+++	++	+++	+	-
Fitting NPCK⁸⁾	++	-	-	-	++	++	+++	+++	++	++	++	++	++	+++	++	-
Fitting CQ⁹⁾	-	++	-	-	-	-	-	-	-	-	-	-	-	-	-	-
Fitting QS-VO¹⁰⁾	+	+	+	+++	+	+	+	+	+	+	+	+	+	+	+	+
Fitting NPQM¹¹⁾	++	++	++	+	+++	++	++	++	++	++	+++	++	++	++	+++	++
Fitting NPQR¹²⁾	++	++	++	+	++	+++	+++	+++	++	++	++	+++	+++	+++	++	++

+++ Recommended tubing/fitting combination

++ Well suited

+ Limited suitability due to:

- Little flexibility when using tubing PLN with fitting CN

- Lack of conductive contacting with PUN-CM

- Incompatible characteristic "resistance to welding spatter" with PUN-VO / PUN-VO-C

- Sub-optimal combination with regard to welding spatter resistance when removing insulation from double-sheathed tubing PAN-VO

Note: Fitting QS-VO is specially designed for tubing PAN-VO with insulation removed using tubing cutter PAN-VOS.

With other fittings, there is a gap in the area of the releasing sleeve and the protective function against welding spatter is lost.

This also increases the risk of the tubing kinking in this area.

However, this risk of kinking can be prevented by ensuring large bending radii when installing the tubing.

- Not suitable

1) For tubing size 4 to 8

2) For tubing size 3 to 8

3) For tubing size 2 to 12, 16 and 22

4) For tubing size 4 to 14

5) For tubing size 4 to 12; 16

6) For tubing size 4 to 12

7) For tubing size 6

8) For tubing size 4 to 10

9) For tubing size 22 and 28 (22 also possible with QS)

10) For tubing size 4 to 12

11) For tubing size 3 to 14

12) For tubing size 4 to 16

Note

Greater force is required when assembling the fittings CK/CN. Expanding the tubing ends using a tapered mandrel makes it easier to push them on.

Datasheet

Plastic tubing PAN

High thermal and mechanical load capacities.



Operating and environmental conditions							
Type	PAN-4	PAN-6	PAN-8	PAN-10	PAN-12	PAN-14	PAN-16
O.D. [mm]	4	6	8	10	12	14	16
Pneumatic connection							
For push-in connector [mm]	4	6	8	10	12	14	16
For barbed connector [mm]	3	4	6	–	–	–	–
For barbed connector with union nut [mm]	3	4	6	–	–	–	–
Temperature-dependent operating pressure [bar]	–0.95 ... +15 → graph	–0.95 ... +19 → graph	–0.95 ... +15 → graph	–0.95 ... +17 → graph	–0.95 ... +17 → graph	–0.95 ... +17 → graph	–0.95 ... +14 → graph
Operating medium	Compressed air to ISO 8573-1:2010 [7:–:–]						
PWIS conformity	VDMA24364-B2-L						
Ambient temperature [°C]	–30 ... +80						
Certification	German Technical Control Board (TÜV)						
Maritime classification	See certificate (colours: silver and natural) ¹⁾					–	See certificate (colours: silver and natural) ¹⁾
Tubing characteristics	Suitable for energy chains in applications with high cycle rates						
Tubing test conditions	Suitable for energy chains: > 5 million cycles to Festo standard 942021						

1) Additional information: www.festo.com/catalogue/... → Support/Downloads.

Operating pressure p as a function of temperature t

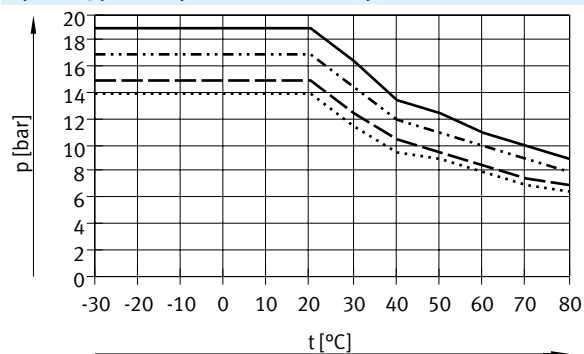

- PAN-6
- - - PAN-4/8
- · - · - PAN-10/12/14
- · · · · PAN-16

Materials	
Shore hardness	D 55 ±3
Tubing	TPE-A
Note on materials	RoHS-compliant
	Free of copper and PTFE

Datasheet

Dimensions – Reel

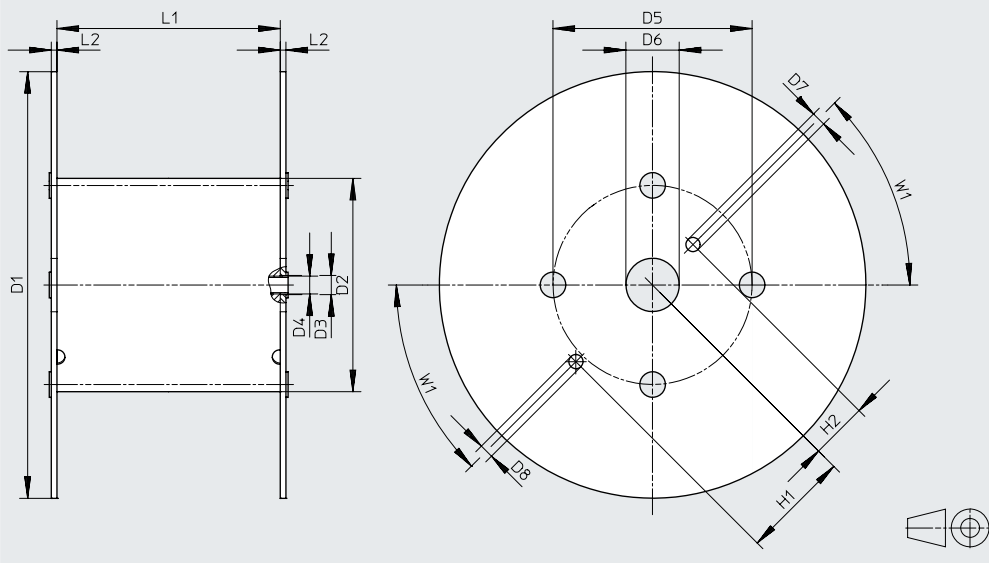

Type	D1 ø	D2 ø	D3 ø	D4 ø	D5 ø	D6 ø	D7 ø	D8 ø	H1	H2	L1	L2	W1
For PAN-4x0.75-...-500	545	246	21	20	216	75	20	20	152.5	80.5	128	8	45°
For PAN-6x1-...-500	545	246	21	20	216	75	20	20	152.5	80.5	128	8	45°
For PAN-8x1.25-...-400	545	310	21	20	280	75	20	20	152.5	80.5	254	8	45°
For PAN-10x1.5-...-300	600	310	21	20	280	75	20	20	152.5	80.5	254	8	45°
For PAN-12x1.75-...-200	600	310	21	20	280	75	20	20	152.5	80.5	254	8	45°
For PAN-16x2-...-100	545	310	21	20	280	75	20	20	152.5	80.5	254	8	45°

Dimensions and ordering data

O.D. [mm]	I.D. [mm]	Min. bending radius [mm]	Flow-relevant bending radius [mm]	Weight [kg/m]	Colour	Part no.	Type	PU ¹⁾ [m]
4	2.9	12	18	0.006	Silver	152697	PAN-4x0.75-SI	50
					Silver	553888	PAN-4x0.75-SI-500	500
					Blue	553906	PAN-4x0.75-BL	50
					Blue	553894	PAN-4x0.75-BL-500	500
					Black	553912	PAN-4x0.75-SW	50
					Black	553900	PAN-4x0.75-SW-500	500
					Natural	546284	PAN-4x0.75-NT	50
					Green	553918	PAN-4x0.75-GN	50
					Red	553924	PAN-4x0.75-RT	50
					Yellow	553930	PAN-4x0.75-GE	50
6	4	14	32	0.016	Silver	152699	PAN-6x1-SI	50
					Silver	553889	PAN-6x1-SI-500	500
					Blue	553907	PAN-6x1-BL	50
					Blue	553895	PAN-6x1-BL-500	500
					Black	553913	PAN-6x1-SW	50
					Black	553901	PAN-6x1-SW-500	500
					Natural	546285	PAN-6x1-NT	50
					Green	553919	PAN-6x1-GN	50
					Red	553925	PAN-6x1-RT	50
					Yellow	553931	PAN-6x1-GE	50

1) Packaging unit

Datasheet

Dimensions and ordering data								
O.D.	I.D.	Min. bending radius	Flow-relevant bending radius	Weight	Colour	Part no.	Type	pU ¹⁾
[mm]	[mm]	[mm]	[mm]	[kg/m]				[m]
8	5.9	22	43	0.024	Silver	152700	PAN-8x1.25-SI	1 ... 50
					Silver	553890	PAN-8x1.25-SI-400	400
					Blue	553908	PAN-8x1.25-BL	1 ... 50
					Blue	553896	PAN-8x1.25-BL-400	400
					Black	553914	PAN-8x1.25-SW	1 ... 50
					Black	553902	PAN-8x1.25-SW-400	400
					Natural	546286	PAN-8x1.25-NT	1 ... 50
					Green	553920	PAN-8x1.25-GN	1 ... 50
					Red	553926	PAN-8x1.25-RT	1 ... 50
					Yellow	553932	PAN-8x1.25-GE	1 ... 50
10	7	27	58	0.042	Silver	152701	PAN-10x1.5-SI	1 ... 50
					Silver	553891	PAN-10x1.5-SI-300	300
					Blue	553909	PAN-10x1.5-BL	1 ... 50
					Blue	553897	PAN-10x1.5-BL-300	300
					Black	553915	PAN-10x1.5-SW	1 ... 50
					Black	553903	PAN-10x1.5-SW-300	300
					Natural	546287	PAN-10x1.5-NT	1 ... 50
					Green	553921	PAN-10x1.5-GN	1 ... 50
					Red	553927	PAN-10x1.5-RT	1 ... 50
					Yellow	553933	PAN-10x1.5-GE	1 ... 50
12	8.4	29	64	0.060	Silver	152702	PAN-12x1.75-SI	1 ... 50
					Silver	553892	PAN-12x1.75-SI-200	200
					Blue	553910	PAN-12x1.75-BL	1 ... 50
					Blue	553898	PAN-12x1.75-BL-200	200
					Black	553916	PAN-12x1.75-SW	1 ... 50
					Black	553904	PAN-12x1.75-SW-200	200
					Natural	546288	PAN-12x1.75-NT	1 ... 50
					Green	553922	PAN-12x1.75-GN	1 ... 50
					Red	553928	PAN-12x1.75-RT	1 ... 50
					Yellow	553934	PAN-12x1.75-GE	1 ... 50
14	10	50	80	0.077	Silver	570392	PAN-14x2-SI	1 ... 50
16	12	67	94	0.092	Silver	152703	PAN-16x2-SI	1 ... 50
					Silver	553893	PAN-16x2-SI-100	100
					Blue	553911	PAN-16x2-BL	1 ... 50
					Blue	553899	PAN-16x2-BL-100	100
					Black	553917	PAN-16x2-SW	1 ... 50
					Black	553905	PAN-16x2-SW-100	100
					Natural	546289	PAN-16x2-NT	1 ... 50
					Green	553923	PAN-16x2-GN	1 ... 50
					Red	553929	PAN-16x2-RT	1 ... 50
					Yellow	553935	PAN-16x2-GE	1 ... 50

1) Packaging unit
Can only be ordered by the metre.

Datasheet

Plastic tubing PAN-R

With O.D. 4 ... 16 mm

For applications with a high pressure range.



Operating and environmental conditions						
Type	PAN-R-4	PAN-R-6	PAN-R-8	PAN-R-10	PAN-R-12	PAN-R-16
O.D. [mm]	4	6	8	10	12	16
Pneumatic connection						
For push-in connector [mm]	4	6	8	10	12	16
Temperature-dependent operating pressure [bar]	-0.95 ... +35 → graph					
Operating medium	Compressed air to ISO 8573-1:2010 [7:-:-]					
Ambient temperature [°C]	-30 ... +80					
PWIS conformity	VDMA24364-B2-L					
Certification	German Technical Control Board (TÜV)					
Certificate-issuing authority	B 013277 0506 00					
Tubing characteristics	Suitable for energy chains in applications with high cycle rates					
Tubing test conditions	Suitable for energy chains: > 5 million cycles to Festo standard 942021					

Operating pressure p as a function of temperature t

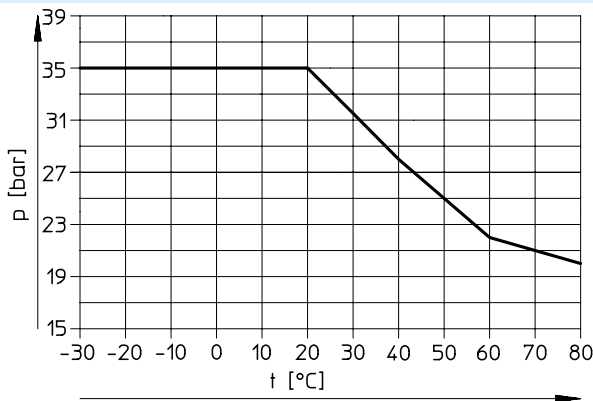

Materials

Shore hardness	D 62 ±3
Tubing	TPE-A
Note on materials	RoHS-compliant
	Free of copper and PTFE

Dimensions and ordering data

O.D.	I.D.	Min. bending radius	Flow-relevant bending radius	Weight	Colour	Part no.	Type	PJ ¹⁾
[mm]	[mm]	[mm]	[mm]	[kg/m]				[m]
4	2.5	10	16	0.0079	Silver	541674	PAN-R-4x0.75-SI	50
6	3.8	16	21	0.0174		541675	PAN-R-6x1.1-SI	50
8	5	20	29	0.0316		541676	PAN-R-8x1.5-SI	1 ... 50
10	6.2	25	44	0.0498		541677	PAN-R-10x1.9-SI	1 ... 50
12	7.6	30	46	0.0698		541678	PAN-R-12x2.2-SI	1 ... 50
16	10	42	73	0.1262		541679	PAN-R-16x3-SI	1 ... 50

1) Packaging unit; can only be ordered by the metre.

Datasheet

Plastic tubing PAN-R

With O.D. 22 and 28 mm

High thermal and mechanical load capacities.



Operating and environmental conditions		
Type	PAN-R-22	PAN-R-28
O.D. [mm]	22	28
Pneumatic connection		
For push-in connector [mm]	22	28
Temperature-dependent operating pressure [bar]	-0.95 ... +14 → graph	
Operating medium	Compressed air to ISO 8573-1:2010 [7:-:-]	
Ambient temperature [°C]	-30 ... +80	
PWIS conformity	VDMA24364-B2-L	

Operating pressure p as a function of temperature t

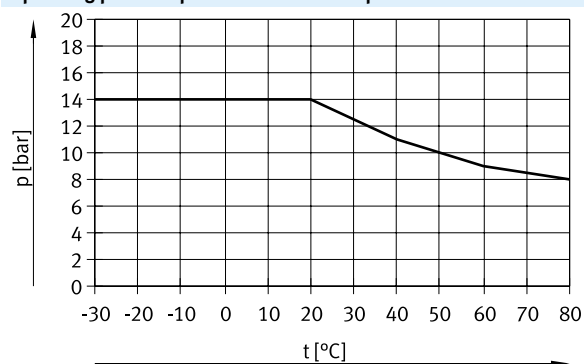

Note

When using the pipe cutter ZR to cut tubing to length, we recommend rotating the tube by approx. 90° at the start of the cutting process.

Rotating the tube gives a drawing cut so that the tube can be cut with a significantly lower force. This also minimises deformation of the tube.

Materials

Shore hardness	D 62 ±3
Tubing	TPE-A
Note on materials	RoHS-compliant
	Free of copper and PTFE

Dimensions and ordering data

O.D. [mm]	I.D. [mm]	Flow-relevant bending radius [mm]	Weight [kg/m]	Colour	Part no.	Type	PJ ¹⁾ [m]
22	18	350	1.31	Black	8036207	PAN-R-22x2-SW	50
28	23	350	2.07		8036208	PAN-R-28x2.5-SW	50

1) Packaging unit

Datasheet

Plastic tubing PAN-MF

High thermal and mechanical load capacities.

Meets the requirements according to DIN 73378 "Polyamide tubing for use in motor vehicles".



Operating and environmental conditions							
Type	PAN-MF-4	PAN-MF-6	PAN-MF-8	PAN-MF-10	PAN-MF-12	PAN-MF-14	PAN-MF-16
O.D. [mm]	4	6	8	10	12	14	16
Pneumatic connection							
For push-in connector [mm]	4	6	8	10	12	14	16
Temperature-dependent operating pressure [bar]	-0.95 ... +31 → graph	-0.95 ... +27 → graph	-0.95 ... +19 → graph	-0.95 ... +19 → graph	-0.95 ... +19 → graph	-0.95 ... +22 → graph	-0.95 ... +19 → graph
Conforms to	DIN 73378-PA12-PHL						
Operating medium	Compressed air to ISO 8573-1:2010 [7:-:-] Mineral oil						
Ambient temperature [°C]	-60 ... +100						
Tubing characteristics	Suitable for energy chains in applications with high cycle rates						
Tubing test conditions	Suitable for energy chains: > 5 million cycles to Festo standard 942021						

Operating pressure p as a function of temperature t

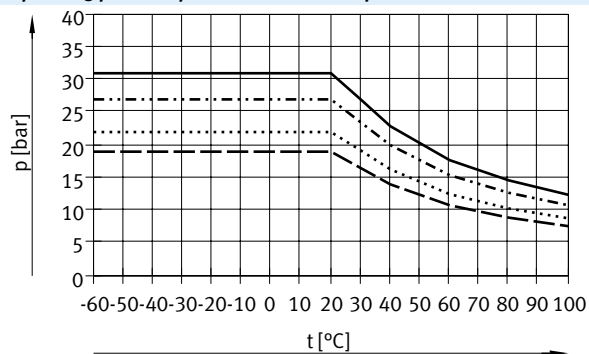

- PAN-MF-4
- - - - - PAN-MF-6
- - - - - PAN-MF-8/10/12/16
- PAN-MF-14

Materials	
Shore hardness	D 65 ±3
Tubing	PA12-P
Note on materials	RoHS-compliant Free of copper and PTFE

Datasheet

Dimensions – Reel

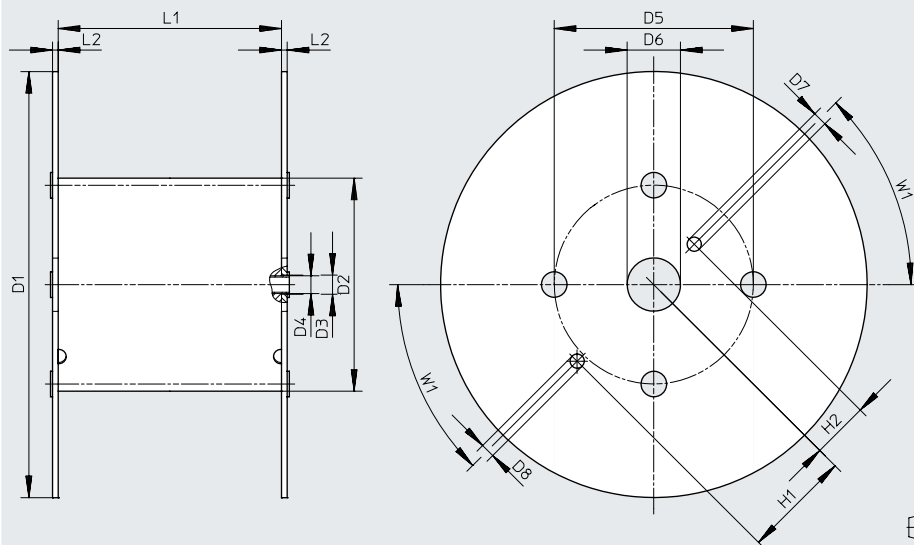

Type	D1 ∅	D2 ∅	D3 ∅	D4 ∅	D5 ∅	D6 ∅	D7 ∅	D8 ∅	H1	H2	L1	L2	W1
For PAN-MF-4x0.75-...-500	545	246	21	20	216	75	20	20	152.5	80.5	128	8	45°
For PAN-MF-6x1-...-500	600	310	21	20	280	75	20	20	152.5	80.5	114	8	45°

Dimensions and ordering data

O.D. [mm]	I.D. [mm]	Min. bending radius [mm]	Flow-relevant bending radius [mm]	Weight [kg/m]	Colour	Part no.	Type	PU ¹⁾ [m]
4	2.5	10	15	0.008	Black	570357	PAN-MF-4x0.75-SW	50
						572091	PAN-MF-4x0.75-SW-500	500
6	4	15	35	0.016		570358	PAN-MF-6x1-SW	50
						572093	PAN-MF-6x1-SW-500	500
8	6	35	50	0.022		570359	PAN-MF-8x1-SW	50
10	7.5	45	65	0.035		570360	PAN-MF-10x1.25-SW	50
12	9	50	70	0.051		570361	PAN-MF-12x1.5-SW	50
14	10	50	75	0.077		570362	PAN-MF-14x2-SW	50
16	12	75	130	0.09		570363	PAN-MF-16x2-SW	50

1) Packaging unit

Datasheet

Plastic tubing PAN-V0

PVC casing, flame-retardant. The tubing casing must be cut to length X (table → 15) before being inserted in the push-in fitting QS-V0.

The tubing cutter PAN-VOS is the perfect tool for this task. The tubing cutter PAN-VOS will always cut the casing to the right length.



Operating and environmental conditions						
Type		PAN-V0-4	PAN-V0-6	PAN-V0-8	PAN-V0-10	PAN-V0-12
O.D.	[mm]	6	8	10	12	14
Pneumatic connection						
	For push-in connector [mm]	4	6	8	10	12
Temperature-dependent operating pressure	[MPa]	-0.095 ... +1.2				
	[bar]	-0.95 ... +12 → graph				
	[psi]	-13.775 ... +174				
Operating medium		Compressed air to ISO 8573-1:2010 [7:-:-]				
		Mineral oil				
		Water as per manufacturer's declaration ¹⁾				
Ambient temperature	[°C]	-30 ... +90				
Material fire test		UL94 V-0 (casing)				

1) Additional information: www.festo.com/catalogue/pan-v0 → Support/Downloads.

Operating pressure p as a function of temperature t

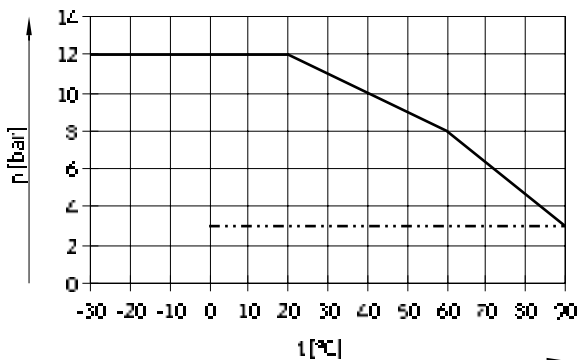

— Air
 - - - - - Water and mineral oil

Materials		
Shore hardness	Outside tubing	A 72 ±4
	Inside tubing	D 57 ±3
Tubing	Outside tubing	PVC-P
	Inside tubing	PA12-P
Note on materials	RoHS-compliant	

Datasheet

Dimensions and ordering data										
O.D.	O.D. for push-in fittings	I.D.	Min. bending radius	Flow-relevant bending radius	Max. cut length X	Weight	Colour	Part no.	Type	pU ¹⁾
[mm]	[mm]	[mm]	[mm]	[mm]	[mm]	[kg/m]				[m]
6	4	2.5	10	20	15	0.0335	Blue	132899	PAN-V0-4x0.75-BL	1 ... 50
8	6	4	13	30	17	0.049	Black	160550	PAN-V0-6x1-SW	1 ... 50
							Blue	132905	PAN-V0-6x1-BL	1 ... 50
							Green	525470	PAN-V0-6x1-GN	1 ... 50
							Red	525474	PAN-V0-6x1-RT	1 ... 50
							White	525478	PAN-V0-6x1-WS	1 ... 50
							Yellow	525482	PAN-V0-6x1-GE	1 ... 50
10	8	6	24	45	18	0.065	Black	160551	PAN-V0-8x1-SW	1 ... 50
							Blue	132906	PAN-V0-8x1-BL	1 ... 50
							Green	525471	PAN-V0-8x1-GN	1 ... 50
							Red	525475	PAN-V0-8x1-RT	1 ... 50
							White	525479	PAN-V0-8x1-WS	1 ... 50
							Yellow	525483	PAN-V0-8x1-GE	1 ... 50
12	10	7.5	34	56	20	0.088	Black	160552	PAN-V0-10x1.25-SW	1 ... 50
							Blue	132907	PAN-V0-10x1.25-BL	1 ... 50
							Green	525472	PAN-V0-10x1.25-GN	1 ... 50
							Red	525476	PAN-V0-10x1.25-RT	1 ... 50
							White	525480	PAN-V0-10x1.25-WS	1 ... 50
							Yellow	525484	PAN-V0-10x1.25-GE	1 ... 50
14	12	9	43	65	23	0.133	Black	160553	PAN-V0-12x1.5-SW	1 ... 50
							Blue	525469	PAN-V0-12x1.5-BL	1 ... 50
							Green	525473	PAN-V0-12x1.5-GN	1 ... 50
							Red	525477	PAN-V0-12x1.5-RT	1 ... 50
							White	525481	PAN-V0-12x1.5-WS	1 ... 50
							Yellow	525485	PAN-V0-12x1.5-GE	1 ... 50

1) Packaging unit
Can only be ordered by the metre.

Ordering data – Modular product system

Ordering table (minimum order quantity 3000 m, rounded value 25 m)											
Size	4	6	8	10	12	14	16	Conditions	Code	Enter code	
Module no.	553610										
Function	Polyamide tubing, standard O.D.									PAN	
Alternative material characteristic	Standard										
	Automotive certification (DIN 73378)									-MF	
	Robust									-R	
Tubing O.D. [mm]	4	–	–	–	–	–	–		-4		
	–	6	–	–	–	–	–		-6		
	–	–	8	–	–	–	–		-8		
	–	–	–	10	–	–	–		-10		
	–	–	–	–	12	–	–		-12		
	–	–	–	–	–	14	–		-14		
	–	–	–	–	–	–	16		-16		
Colour	Silver									-SI	
	Blue									-BL	
	Black									-SW	
	Yellow									-GE	
	Green									-GN	
	Red									-RT	
	Brown									-BR	
	White									-WS	
Natural									-NT		
Labelling text (on request)	Standard										
	Customer-specific tubing inscription									[1]	-TXT
Packaging unit [m]	25									-25	
	50									-50	
	100									-100	
	200									-200	
	300									-300	
	400									-400	
	500									-500	
Packaging	Cardboard box									[2]	-CB
	Reel									[3]	-HA

- [1] TXT Only on request
- [2] CB Only with packaging unit 25, 50
- [3] HA Not with packaging unit 25, 50

Datasheet

Plastic tubing PFAN

Pneumatic tubing with resistance to high temperatures and chemicals.

Suitable for contact with food.



Operating and environmental conditions							
Type		PFAN-3	PFAN-4	PFAN-6	PFAN-8	PFAN-10	PFAN-12
O.D.	[mm]	3	4	6	8	10	12
Pneumatic connection							
	For push-in connector [mm]	3	4	6	8	10	12
	For barbed connector [mm]	2	3	4	6	-	-
	For barbed connector with union nut [mm]	-	3	4	6	-	-
Temperature-dependent operating pressure	[bar]	-0.95 ... +15 → graph	-0.95 ... +15 → graph	-0.95 ... +16 → graph	-0.95 ... +15 → graph	-0.95 ... +16 → graph	-0.95 ... +16 → graph
Note on operating pressure		Water: 0 - 0.6 MPa,... Steam: 0 - 0.15 MPa,...					
Operating medium		Compressed air to ISO 8573-1:2010 [7:-:-] Water (liquid, ice-free) ¹⁾ Water vapour ¹⁾					
Note on temperature of medium		Water vapour: 0 - 85°C Steam: max. 120°C					
Ambient temperature	[°C]	-20 ... +150					
Food-safe		See supplementary material information ¹⁾ See declaration of conformity ¹⁾					
Material fire test		UL94 V-0					
Certification		German Technical Control Board (TÜV)					

1) Additional information: www.festo.com/catalogue/... → Support/Downloads.

Operating pressure p as a function of temperature t

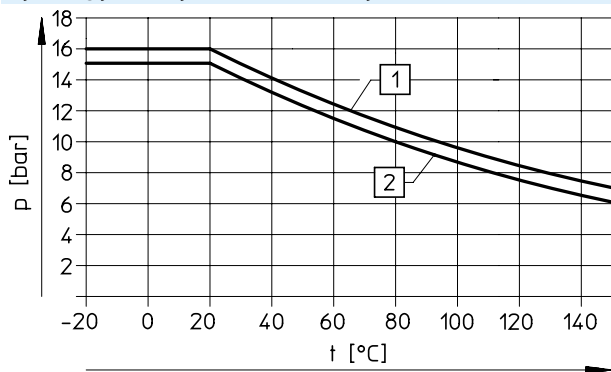

[1] PFAN-6/10/12

[2] PFAN-3/4/8

Datasheet

Materials	
Shore hardness	D 60 +5
Tubing	PFA
Note on materials	RoHS-compliant
	Not printed

Dimensions and ordering data								
O.D.	I.D.	Min. bending radius	Flow-relevant bending radius	Weight	Colour	Part no.	Type	PU ¹⁾
[mm]	[mm]	[mm]	[mm]	[kg/m]				[m]
3	2.3	10	30	0.0075	Natural	8061167	PFAN-3x0.5-NT	1 ... 50
4	2.9	11	37	0.012		197061	PFAN-4x0.75-NT	1 ... 50
6	4	12	50	0.034		197062	PFAN-6x1-NT	1 ... 50
8	5.9	25	110	0.049		197063	PFAN-8x1.25-NT	1 ... 50
10	7	22	140	0.087		197064	PFAN-10x1.5-NT	1 ... 50
12	8.4	29	165	0.125		197065	PFAN-12x1.75-NT	1 ... 50

1) Packaging unit
Can only be ordered by the metre.

Datasheet

Plastic tubing PTFEN

Pneumatic tubing with resistance to high temperatures and chemicals.



Operating and environmental conditions								
Type		PTFEN-4	PTFEN-6	PTFEN-8	PTFEN-10	PTFEN-12	PTFEN-14	PTFEN-16
O.D.	[mm]	4	6	8	10	12	14	16
Pneumatic connection								
For push-in connector	[mm]	4	6	8	10	12	14	16
For barbed connector	[mm]	3	4	6	–	–	–	–
For barbed connector with union nut	[mm]	3	4	6	–	–	–	–
Temperature-dependent operating pressure	[bar]	–0.95 ... +12 → graph	–0.95 ... +15 → graph	–0.95 ... +12 → graph	–0.95 ... +12 → graph	–0.95 ... +12 → graph	–0.95 ... +12 → graph	–0.95 ... +12 → graph
Operating medium		Compressed air to ISO 8573-1:2010 [7:–:–]						
Ambient temperature	[°C]	–20 ... +150						
Food-safe ¹⁾		See supplementary material information						
Material fire test		UL94 V-0						

1) Additional information: www.festo.com/catalogue/... → Support/Downloads.

Operating pressure p as a function of temperature t

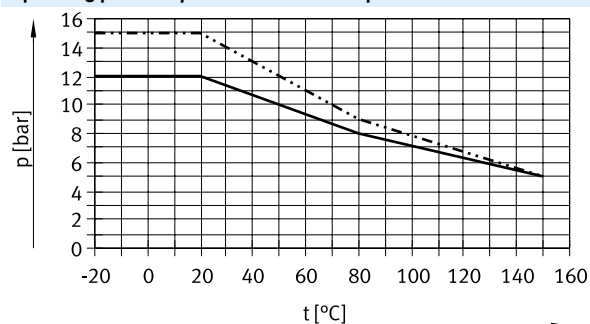

— PTFEN-4/8/10/12/14/16
 PTFEN-6

Materials	
Shore hardness	D 55 ±5
Tubing	PTFE
Note on materials	RoHS-compliant

Datasheet

Ordering data								
O.D.	I.D.	Min. bending radius	Flow-relevant bending radius	Weight	Colour	Part no.	Type	PJ ¹⁾
[mm]	[mm]	[mm]	[mm]	[kg/m]				[m]
4	2.9	32	32	0.013	Natural	8061171	PTFEN-4X0.5-NT-100	100
6	4	38	40	0.034		8061172	PTFEN-6X1-NT-100	100
						8061178	PTFEN-6X1-NT-500	500
8	5.9	64	90	0.047		8061173	PTFEN-8X1-NT	1 ... 50
						8061179	PTFEN-8X1-NT-400	400
10	7	70	100	0.086		8061174	PTFEN-10X1.5-NT	1 ... 50
						8061180	PTFEN-10X1.5-NT-300	300
12	8.4	84	120	0.124		8061175	PTFEN-12X2-NT	1 ... 50
14	10	106	120	0.162		8061176	PTFEN-14X2-NT	1 ... 50
16	11	109	160	0.228		8061177	PTFEN-16X2.5-NT-25	1 ... 25

1) Packaging unit
Can only be ordered by the metre.

 **Note**

Do not bend tubing!

It is crucial that, when using cable binders during assembly and operation, the tubing is not bent or excessively constricted.

This could damage the tubing and cause it to split at the bend after a short while under normal operating conditions.

Datasheet

Plastic tubing PEN

Polyethylene tubing is characterised by good resistance to chemicals and hydrolysis. It is resistant to most cleaning agents and lubricants.



Operating and environmental conditions								
Type		PEN-4	PEN-6	PEN-8	PEN-10	PEN-12	PEN-14	PEN-16
O.D.	[mm]	4	6	8	10	12	14	16
Pneumatic connection								
	For push-in connector [mm]	4	6	8	10	12	14	16
	For barbed connector [mm]	3	4	6	–	–	–	–
	For barbed connector with union nut [mm]	3	4	6	–	–	–	–
Temperature-dependent operating pressure	[bar]	–0.95 ... +10 → graph						
Operating medium		Compressed air to ISO 8573-1:2010 [7:-:-]						
		Water as per manufacturer's declaration ¹⁾						
PWIS conformity		VDMA24364-B2-L						
Ambient temperature	[°C]	–30 ... +60						
Certification		German Technical Control Board (TÜV)						
Certificate-issuing authority		B 013277 0506 00						
Tubing characteristics		Suitable for energy chains in applications with high cycle rates						
Tubing test conditions		Suitable for energy chains: > 5 million cycles to Festo standard 942021						

1) Additional information: www.festo.com/catalogue/... → Support/Downloads.

Operating pressure p as a function of temperature t

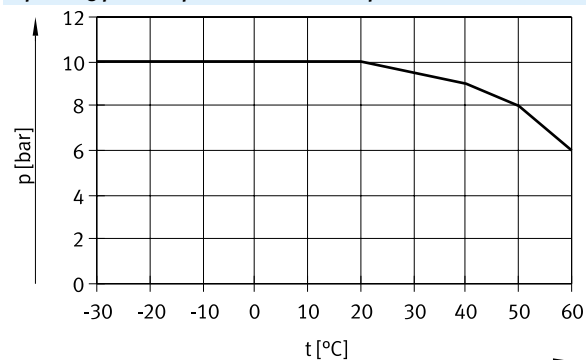

Datasheet

Materials	
Shore hardness	D 52 ±3
Tubing	PU
Note on materials	RoHS-compliant
	Free of copper and PTFE

Dimensions – Reel

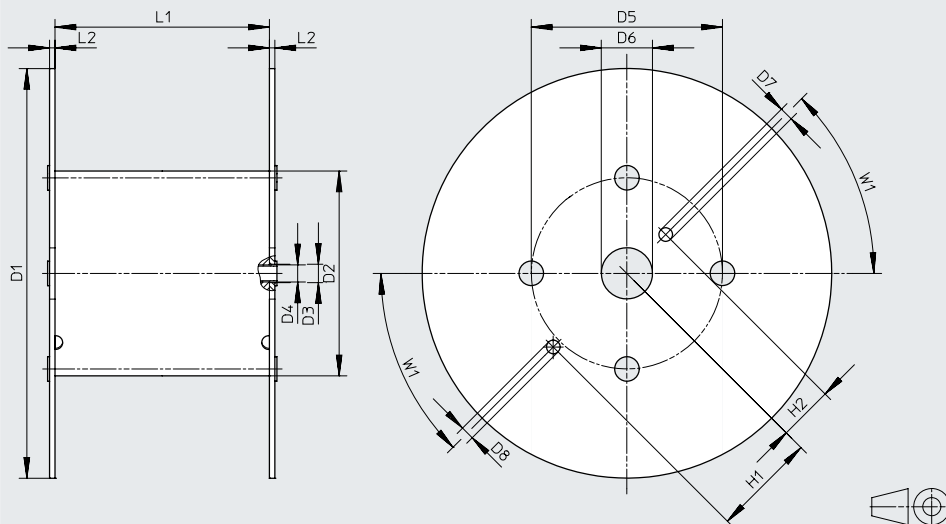

Type	D1 ø	D2 ø	D3 ø	D4 ø	D5 ø	D6 ø	D7 ø	D8 ø	H1	H2	L1	L2	W1
For PEN-4x0.75-...-500	545	246	21	20	216	75	20	20	152.5	80.5	128	8	45°
For PEN-6x1-...-500	545	246	21	20	216	75	20	20	152.5	80.5	128	8	45°
For PEN-8x1.25-...-400	545	310	21	20	280	75	20	20	152.5	80.5	254	8	45°
For PEN-10x1.5-...-300	600	310	21	20	280	75	20	20	152.5	80.5	254	8	45°
For PEN-12x1.75-...-200	600	310	21	20	280	75	20	20	152.5	80.5	254	8	45°
For PEN-16x2.5-...-100	545	310	21	20	280	75	20	20	152.5	80.5	254	8	45°

Dimensions and ordering data

O.D. [mm]	I.D. [mm]	Min. bending radius [mm]	Flow-relevant bending radius [mm]	Weight [kg/m]	Colour	Part no.	Type	PJ ¹⁾ [m]
4	2.7	10	20	0.0064	Black	543240	PEN-4x0.75-SW	50
					Black	551438	PEN-4x0.75-SW-500	500
					Blue	551456	PEN-4x0.75-BL	50
					Blue	551444	PEN-4x0.75-BL-500	500
					Silver	551462	PEN-4x0.75-SI	50
					Silver	551450	PEN-4x0.75-SI-500	500
					Natural	543246	PEN-4x0.75-NT	50
					Green	551468	PEN-4x0.75-GN	50
					Red	551474	PEN-4x0.75-RT	50
6	4	13.5	26	0.0148	Black	543241	PEN-6x1-SW	50
					Black	551439	PEN-6x1-SW-500	500
					Blue	551457	PEN-6x1-BL	50
					Blue	551445	PEN-6x1-BL-500	500
					Silver	551463	PEN-6x1-SI	50
					Silver	551451	PEN-6x1-SI-500	500
					Natural	543247	PEN-6x1-NT	50
					Green	551469	PEN-6x1-GN	50
					Red	551475	PEN-6x1-RT	50
Yellow	551481	PEN-6x1-GE	50					

1) Packaging unit

Datasheet

Dimensions and ordering data								
O.D.	I.D.	Min. bending radius	Flow-relevant bending radius	Weight	Colour	Part no.	Type	pU ¹⁾
[mm]	[mm]	[mm]	[mm]	[kg/m]				[m]
8	5.7	22.5	35	0.0233	Black	543242	PEN-8x1.25-SW	50
					Black	551440	PEN-8x1.25-SW-400	400
					Blue	551458	PEN-8x1.25-BL	50
					Blue	551446	PEN-8x1.25-BL-400	400
					Silver	551464	PEN-8x1.25-SI	50
					Silver	551452	PEN-8x1.25-SI-400	400
					Natural	543248	PEN-8x1.25-NT	50
					Green	551470	PEN-8x1.25-GN	50
					Red	551476	PEN-8x1.25-RT	50
					Yellow	551482	PEN-8x1.25-GE	50
10	7	23.5	40	0.0377	Black	543243	PEN-10x1.5-SW	50
					Black	551441	PEN-10x1.5-SW-300	300
					Blue	551459	PEN-10x1.5-BL	50
					Blue	551447	PEN-10x1.5-BL-300	300
					Silver	551465	PEN-10x1.5-SI	50
					Silver	551453	PEN-10x1.5-SI-300	300
					Natural	543249	PEN-10x1.5-NT	50
					Green	551471	PEN-10x1.5-GN	50
					Red	551477	PEN-10x1.5-RT	50
					Yellow	551483	PEN-10x1.5-GE	50
12	8.4	33	58	0.0542	Black	543244	PEN-12x1.75-SW	50
					Black	551442	PEN-12x1.75-SW-200	200
					Blue	551460	PEN-12x1.75-BL	50
					Blue	551448	PEN-12x1.75-BL-200	200
					Silver	551466	PEN-12x1.75-SI	50
					Silver	551454	PEN-12x1.75-SI-200	200
					Natural	543250	PEN-12x1.75-NT	50
					Green	551472	PEN-12x1.75-GN	50
					Red	551478	PEN-12x1.75-RT	50
					Yellow	551484	PEN-12x1.75-GE	50
14	9.5	45	80	0.0773	Black	570516	PEN-14x2-SW	50
					Natural	570517	PEN-14x2-NT	50
16	10.8	57.5	122	0.1029	Black	543245	PEN-16x2.5-SW	50
					Black	551443	PEN-16x2.5-SW-100	100
					Blue	551461	PEN-16x2.5-BL	50
					Blue	551449	PEN-16x2.5-BL-100	100
					Silver	551467	PEN-16x2.5-SI	50
					Silver	551455	PEN-16x2.5-SI-100	100
					Natural	543251	PEN-16x2.5-NT	50
					Green	551473	PEN-16x2.5-GN	50
					Red	551479	PEN-16x2.5-RT	50
					Yellow	551485	PEN-16x2.5-GE	50

1) Packaging unit

Ordering data – Modular product system

Ordering table (minimum order quantity 3000 m, rounded value 25 m)											
Size	4	6	8	10	12	14	16	Conditions	Code	Enter code	
Module no.	553769										
Function	Polyethylene tubing, standard O.D., economical									PEN	
Tubing O.D. [mm]	4	–	–	–	–	–	–			-4	
	–	6	–	–	–	–	–			-6	
	–	–	8	–	–	–	–			-8	
	–	–	–	10	–	–	–			-10	
	–	–	–	–	12	–	–			-12	
	–	–	–	–	–	14	–			-14	
	–	–	–	–	–	–	16			-16	
Colour	Silver									-SI	
	Blue									-BL	
	Black									-SW	
	Yellow									-GE	
	Green									-GN	
	Red									-RT	
	Brown									-BR	
	White									-WS	
	Natural									-NT	
Labelling text (on request)	Standard										
	Customer-specific tubing inscription									[1]	-TXT
Packaging unit [m]	25									-25	
	50									-50	
	100									-100	
	200						–	–		-200	
	300					–	–	–		-300	
	400				–	–	–	–		-400	
	500			–	–	–	–	–		-500	
Packaging	Cardboard box									[2]	-CB
	Reel									[3]	-HA

- [1] TXT Only on request
- [2] CB Only with packaging unit 25, 50
- [3] HA Not with packaging unit 25, 50

Datasheet

Plastic tubing PLN

Polyethylene tubing is characterised by good resistance to chemicals and hydrolysis. It is resistant to most cleaning agents and lubricants.



Operating and environmental conditions								
Type		PLN-4	PLN-6	PLN-8	PLN-10	PLN-12	PLN-14	PLN-16
O.D.	[mm]	4	6	8	10	12	14	16
Pneumatic connection								
	For push-in connector [mm]	4	6	8	10	12	14	16
	For barbed connector [mm]	3	4	6	–	–	–	–
	For barbed connector with union nut [mm]	3	4	6	–	–	–	–
Temperature-dependent operating pressure	[bar]	–0.95 ... +14 → graph						
Operating medium		Compressed air to ISO 8573-1:2010 [7:-:-]						
		Water as per manufacturer's declaration ¹⁾						
PWIS conformity		VDMA24364-B2-L						
Ambient temperature	[°C]	–30 ... +80						
Food-safe ¹⁾		See supplementary material information						
Certification		German Technical Control Board (TÜV)						
Certificate-issuing authority		B 013277 0506 00						

1) Additional information: www.festo.com/catalogue/... → Support/Downloads.

Operating pressure p as a function of temperature t

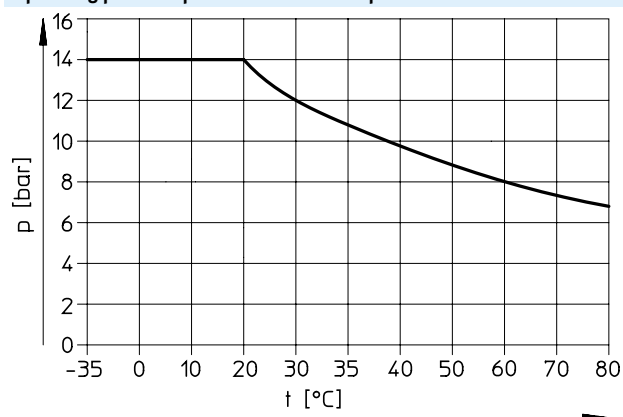

Datasheet

Materials	
Shore hardness	D 59 ±3
Tubing	PU
Note on materials	RoHS-compliant
	Free of copper and PTFE

Dimensions and ordering data								
O.D.	I.D.	Min. bending radius	Flow-relevant bending radius	Weight	Colour	Part no.	Type	PU ¹⁾
[mm]	[mm]	[mm]	[mm]	[kg/m]				[m]
4	2.9	12	25	0.0056	Natural	193403	PLN-4x0.75-NT	50
					Black	195280	PLN-4x0.75-SW	50
					Blue	558205	PLN-4x0.75-BL	50
					Silver	558211	PLN-4x0.75-SI	50
					Red	558217	PLN-4x0.75-RT	50
6	4	11	32	0.0147	Natural	193404	PLN-6x1-NT	50
					Black	195281	PLN-6x1-SW	50
					Blue	558206	PLN-6x1-BL	50
					Silver	558212	PLN-6x1-SI	50
					Red	558218	PLN-6x1-RT	50
8	5.9	23	50	0.0214	Natural	193405	PLN-8x1.25-NT	1 ... 50
					Black	195282	PLN-8x1.25-SW	1 ... 50
					Blue	558207	PLN-8x1.25-BL	1 ... 50
					Silver	558213	PLN-8x1.25-SI	1 ... 50
					Red	558219	PLN-8x1.25-RT	1 ... 50
10	7	22	57	0.0375	Natural	193406	PLN-10x1.5-NT	1 ... 50
					Black	195283	PLN-10x1.5-SW	1 ... 50
					Blue	558208	PLN-10x1.5-BL	1 ... 50
					Silver	558214	PLN-10x1.5-SI	1 ... 50
					Red	558220	PLN-10x1.5-RT	1 ... 50
12	8.4	23	65	0.054	Natural	193407	PLN-12x1.75-NT	1 ... 50
					Black	195284	PLN-12x1.75-SW	1 ... 50
					Blue	558209	PLN-12x1.75-BL	1 ... 50
					Silver	558215	PLN-12x1.75-SI	1 ... 50
					Red	558221	PLN-12x1.75-RT	1 ... 50
14	10	40	80	0.07	Natural	570424	PLN-14x2-NT	1 ... 50
					Black	570423	PLN-14x2-SW	1 ... 50
16	12	55	95	0.082	Natural	539064	PLN-16x2-NT	1 ... 50
					Black	539065	PLN-16x2-SW	1 ... 50
					Blue	558210	PLN-16x2-BL	1 ... 50
					Silver	558216	PLN-16x2-SI	1 ... 50
					Red	558222	PLN-16x2-RT	1 ... 50

1) Packaging unit
Can only be ordered by the metre.

Ordering data – Modular product system

Ordering table (minimum order quantity 3000 m, rounded value 25 m)											
Size	4	6	8	10	12	14	16	Conditions	Code	Enter code	
Module no.	553850										
Function	Polyethylene tubing, standard O.D., resistant to cleaning agents									PLN	
Tubing O.D. [mm]	4	–	–	–	–	–	–			-4	
	–	6	–	–	–	–	–			-6	
	–	–	8	–	–	–	–			-8	
	–	–	–	10	–	–	–			-10	
	–	–	–	–	12	–	–			-12	
	–	–	–	–	–	14	–			-14	
	–	–	–	–	–	–	16			-16	
Colour	Silver									-SI	
	Blue									-BL	
	Black									-SW	
	Yellow									-GE	
	Green									-GN	
	Red									-RT	
	Brown									-BR	
	White									-WS	
	Natural									-NT	
Labelling text (on request)	Standard										
	Customer-specific tubing inscription								[1]		-TXT
Packaging unit [m]	25										-25
	50										-50
	100										-100
	200					–	–				-200
	300				–	–	–				-300
	400			–	–	–	–				-400
	500		–	–	–	–	–				-500
Packaging	Cardboard box								[2]		-CB
	Reel								[3]		-HA

- [1] TXT Only on request
 [2] CB Only with packaging unit 25, 50
 [3] HA Not with packaging unit 25, 50

Datasheet

Plastic tubing PUN

Highly flexible plastic tubing

 **Note**

The plastic tubing may only be installed in contact with cables if their sheathing is free from phosphoric acid esters. Failure to observe this can result in damage to the plastic tubing.

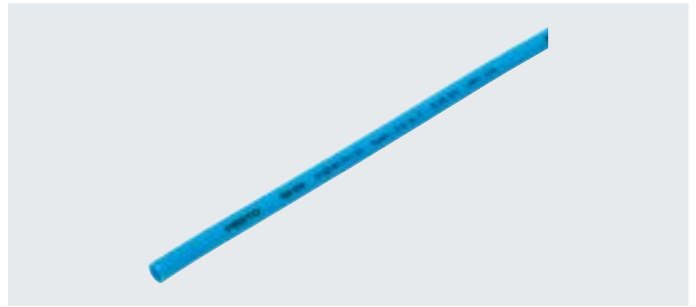

Operating and environmental conditions									
Type		PUN-3	PUN-4	PUN-6	PUN-8	PUN-10	PUN-12	PUN-14	PUN-16
O.D.	[mm]	3	4	6	8	10	12	14	16
Pneumatic connection									
For push-in connector	[mm]	3	4	6	8	10	12	14	16
For barbed connector	[mm]	2	3	4	6	–	–	–	–
For barbed connector with union nut	[mm]	–	3	4	6	–	–	–	–
Temperature-dependent operating pressure	[bar]	–0.95 ... +10 → graph							
Operating medium		Compressed air to ISO 8573-1:2010 [7:-:-]							
PWIS conformity		VDMA24364-B2-L							
Ambient temperature	[°C]	–35 ... +60							
Material fire test		UL94 HB							
Certification		German Technical Control Board (TÜV)							
Certificate-issuing authority		B 013277 0506 00							
Tubing characteristics		Suitable for energy chains in applications with high cycle rates							
Tubing test conditions		Suitable for energy chains: > 5 million cycles to Festo standard 942021							

Operating pressure p as a function of temperature t

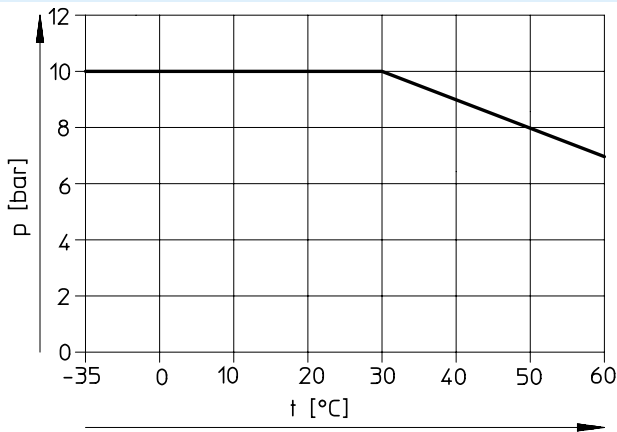

Datasheet

Materials	
Shore hardness	D 52 ±3
Tubing	TPE-U(PU)
Note on materials	RoHS-compliant
	Free of copper and PTFE

Dimensions – Reel

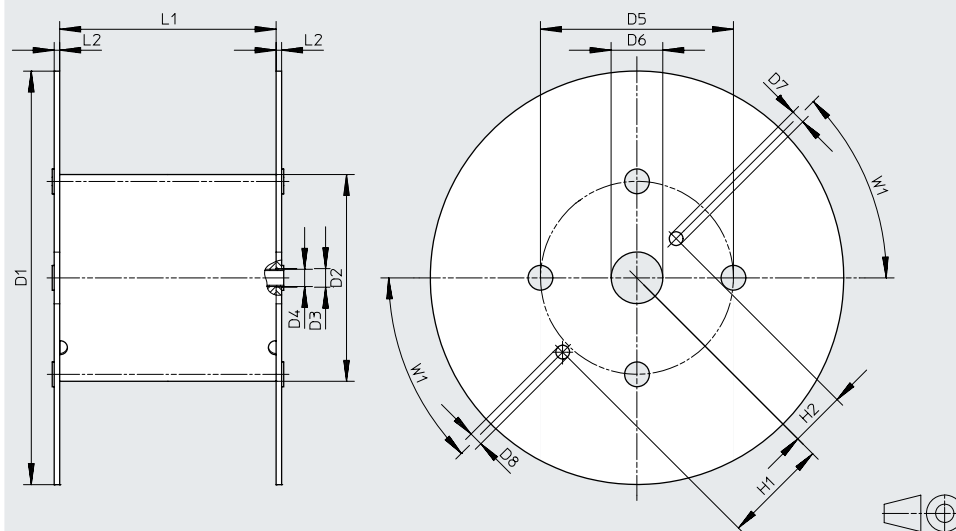

Type	D1 ø	D2 ø	D3 ø	D4 ø	D5 ø	D6 ø	D7 ø	D8 ø	H1	H2	L1	L2	W1
For PUN-3x0.5-...-500	545	246	21	20	216	75	20	20	152.5	80.5	128	8	45°
For PUN-4x0.75-...-500	545	246	21	20	216	75	20	20	152.5	80.5	128	8	45°
For PUN-6x1-...-500	600	310	21	20	280	75	20	20	152.5	80.5	114	8	45°
For PUN-8x1.25-...-400	545	310	21	20	280	75	20	20	152.5	80.5	254	8	45°
For PUN-10x1.5-...-300	600	310	21	20	280	75	20	20	152.5	80.5	254	8	45°
For PUN-12x2-...-200	600	310	21	20	280	75	20	20	152.5	80.5	254	8	45°
For PUN-16x2.5-...-100	545	310	21	20	280	75	20	20	152.5	80.5	254	8	45°

Dimensions and ordering data

O.D. [mm]	I.D. [mm]	Min. bending radius [mm]	Flow-relevant bending radius [mm]	Weight [kg/m]	Colour	Part no.	Type	PU ¹⁾ [m]
3	2.1	9	12	0.0044	Silver	152583	PUN-3x0.5-SI	50
					Silver	525738	PUN-3x0.5-SI-500	500
					Blue	159660	PUN-3x0.5-BL	50
					Blue	525745	PUN-3x0.5-BL-500	500
					Black	159661	PUN-3x0.5-SW	50
					Black	553936	PUN-3x0.5-SW-500	500
					Yellow	178416	PUN-3x0.5-GE	50
					Green	178423	PUN-3x0.5-GN	50
					Red	178409	PUN-3x0.5-RT	50
4	2.6	8	17	0.0089	Silver	152584	PUN-4x0.75-SI	50
					Silver	525739	PUN-4x0.75-SI-500	500
					Blue	159662	PUN-4x0.75-BL	50
					Blue	525746	PUN-4x0.75-BL-500	500
					Black	159663	PUN-4x0.75-SW	50
					Black	553937	PUN-4x0.75-SW-500	500
					Yellow	178417	PUN-4x0.75-GE	50
					Green	178424	PUN-4x0.75-GN	50
					Red	178410	PUN-4x0.75-RT	50

1) Packaging unit

Datasheet

Dimensions and ordering data								
O.D.	I.D.	Min. bending radius	Flow-relevant bending radius	Weight	Colour	Part no.	Type	PJ ¹⁾
[mm]	[mm]	[mm]	[mm]	[kg/m]				[m]
6	4.0	16	26.5	0.0192	Silver	152586	PUN-6x1-SI	50
					Silver	525740	PUN-6x1-SI-500	500
					Blue	159664	PUN-6x1-BL	50
					Blue	525747	PUN-6x1-BL-500	500
					Black	159665	PUN-6x1-SW	50
					Black	553938	PUN-6x1-SW-500	500
					Yellow	178418	PUN-6x1-GE	50
					Green	178425	PUN-6x1-GN	50
					Red	178411	PUN-6x1-RT	50
8	5.7	24	37	0.0302	Silver	152587	PUN-8x1.25-SI	1 ... 50
					Silver	525741	PUN-8x1.25-SI-400	400
					Blue	159666	PUN-8x1.25-BL	1 ... 50
					Blue	525748	PUN-8x1.25-BL-400	400
					Black	159667	PUN-8x1.25-SW	1 ... 50
					Black	553939	PUN-8x1.25-SW-400	400
					Yellow	178419	PUN-8x1.25-GE	1 ... 50
					Green	178426	PUN-8x1.25-GN	1 ... 50
					Red	178412	PUN-8x1.25-RT	1 ... 50
10	7.0	28	54	0.0489	Silver	152588	PUN-10x1.5-SI	1 ... 50
					Silver	525742	PUN-10x1.5-SI-300	300
					Blue	159668	PUN-10x1.5-BL	1 ... 50
					Blue	525749	PUN-10x1.5-BL-300	300
					Black	159669	PUN-10x1.5-SW	1 ... 50
					Black	553940	PUN-10x1.5-SW-300	300
					Yellow	178420	PUN-10x1.5-GE	1 ... 50
					Green	178427	PUN-10x1.5-GN	1 ... 50
					Red	178413	PUN-10x1.5-RT	1 ... 50
12	8.0	33	62	0.0767	Silver	152589	PUN-12x2-SI	1 ... 50
					Silver	525743	PUN-12x2-SI-200	200
					Blue	159670	PUN-12x2-BL	1 ... 50
					Blue	525750	PUN-12x2-BL-200	200
					Black	159671	PUN-12x2-SW	1 ... 50
					Black	553941	PUN-12x2-SW-200	200
					Yellow	178421	PUN-12x2-GE	1 ... 50
					Green	178428	PUN-12x2-GN	1 ... 50
					Red	178414	PUN-12x2-RT	1 ... 50
14	9.8	45	84	0.0949	Silver	570389	PUN-14x2-SI	1 ... 50
					Blue	570390	PUN-14x2-BL	1 ... 50
					Black	570391	PUN-14x2-SW	1 ... 50
16	11.0	45	88	0.1294	Silver	152590	PUN-16x2.5-SI	1 ... 50
					Silver	525744	PUN-16x2.5-SI-100	100
					Blue	159672	PUN-16x2.5-BL	1 ... 50
					Blue	525751	PUN-16x2.5-BL-100	100
					Black	159673	PUN-16x2.5-SW	1 ... 50
					Black	553942	PUN-16x2.5-SW-100	100
					Yellow	178422	PUN-16x2.5-GE	1 ... 50
					Green	178429	PUN-16x2.5-GN	1 ... 50
					Red	178415	PUN-16x2.5-RT	1 ... 50

1) Packaging unit
Can only be ordered by the metre.

Datasheet

DUO tubing PUN-DUO

Highly flexible paired plastic tubing characterised by great resistance to abrasion and kinks.

Two lengths of tubing are fused together into a tubing pair. For fitting, the paired tubing is separated as required at both ends.

Note

The plastic tubing may only be installed in contact with cables if their sheathing is free from phosphoric acid esters. Failure to observe this can result in damage to the plastic tubing.



Operating and environmental conditions					
Type		PUN-4-...-DUO	PUN-6-...-DUO	PUN-8-...-DUO	PUN-10-...-DUO
O.D.	[mm]	4	6	8	10
Pneumatic connection					
For push-in connector	[mm]	4	6	8	10
For barbed connector	[mm]	3	4	6	–
For barbed connector with union nut	[mm]	3	4	6	–
Temperature-dependent operating pressure	[bar]	–0.95 ... +10 → graph			
Operating medium		Compressed air to ISO 8573-1:2010 [7:--:-]			
PWIS conformity		VDMA24364-B2-L			
Ambient temperature	[°C]	–35 ... +60			
Material fire test		UL94 HB			
Certification		German Technical Control Board (TÜV)			
Certificate-issuing authority		B 013277 0506 00			
Tubing characteristics		Suitable for energy chains in applications with high cycle rates			
Tubing test conditions		Suitable for energy chains: > 5 million cycles to Festo standard 942021			

Operating pressure p as a function of temperature t

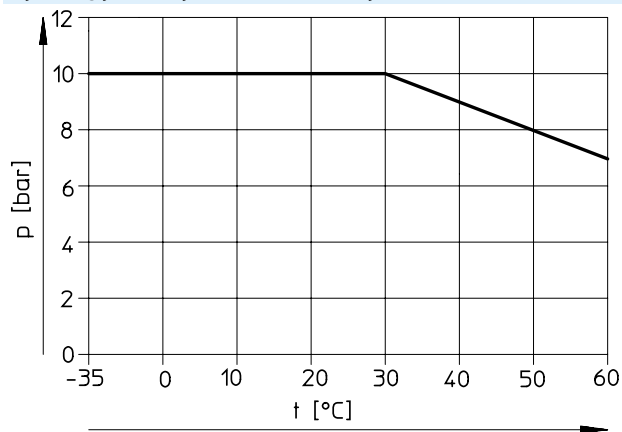

Datasheet

Materials	
Shore hardness	D 52 ±3
Tubing	TPE-U(PU)
Note on materials	RoHS-compliant
	Free of copper and PTFE

Dimensions and ordering data								
O.D.	I.D.	Min. bending radius	Flow-relevant bending radius	Weight	Colour	Part no.	Type	PU ¹⁾
[mm]	[mm]	[mm]	[mm]	[kg/m]				[m]
4	2.6	8	17	0.0178	Silver	152822	PUN-4x0.75-DUO-SI	50
					Blue/black	159674	PUN-4x0.75-DUO-BS	50
6	4	16	26.5	0.0384	Silver	152823	PUN-6x1-DUO-SI	50
					Blue/black	159675	PUN-6x1-DUO-BS	50
8	5.7	24	37	0.0604	Silver	152824	PUN-8x1.25-DUO-SI	1 ... 50
					Blue/black	159676	PUN-8x1.25-DUO-BS	1 ... 50
10	7	28	54	0.0978	Silver	152825	PUN-10x1.5-DUO-SI	1 ... 50
					Blue/black	159677	PUN-10x1.5-DUO-BS	1 ... 50

- 1) Packaging unit
Can only be ordered by the metre.

Datasheet

Plastic tubing PUN-CM

Highly flexible plastic tubing, electrically conductive.



Operating and environmental conditions						
Type		PUN-CM-4	PUN-CM-6	PUN-CM-8	PUN-CM-10	PUN-CM-12
O.D.	[mm]	4	6	8	10	12
Pneumatic connection						
For push-in connector	[mm]	4	6	8	10	12
Temperature-dependent operating pressure	[MPa]	-0.095 ... +1				
	[bar]	-0.95 ... +10 → graph				
	[psi]	-13.775 ... +145				
Operating medium		Compressed air to ISO 8573-1:2010 [7:-:-]				
PWIS conformity		VDMA24364-B2-L				
Ambient temperature	[°C]	-35 ... +60				
Surface resistance	[Ω]	10 ⁴ ... 10 ⁷				
Tubing characteristics		Suitable for energy chains in applications with high cycle rates				
Tubing test conditions		Suitable for energy chains: > 5 million cycles to Festo standard 942021				

Operating pressure p as a function of temperature t

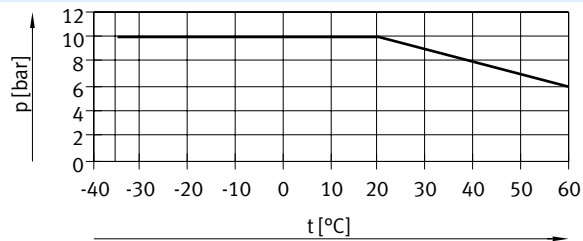

Materials	
Shore hardness	D 52 ±3
Tubing	TPE-U(PU)
Note on materials	RoHS-compliant
	Free of copper and PTFE
	Ester-/ether-based

Datasheet

Dimensions and ordering data								
O.D.	I.D.	Min. bending radius	Flow-relevant bending radius	Weight	Colour	Part no.	Type	PJ ¹⁾
[mm]	[mm]	[mm]	[mm]	[kg/m]				[m]
4	2.5	8	17	0.00993	Black	188882	PUN-CM-4-SW	50
6	4	14	28	0.02125		188883	PUN-CM-6-SW	50
8	5.5	20	37	0.03527		130816	PUN-CM-8-SW	1 ... 50
10	7	30	60	0.05158		130817	PUN-CM-10-SW	1 ... 50
12	8	30	70	0.08107		130818	PUN-CM-12-SW	1 ... 50
14	9.8	41	80	0.095		Modular product system → 49		

1) Packaging unit
Can only be ordered by the metre.

Datasheet

Plastic tubing PUN-H

With O.D. 2 mm

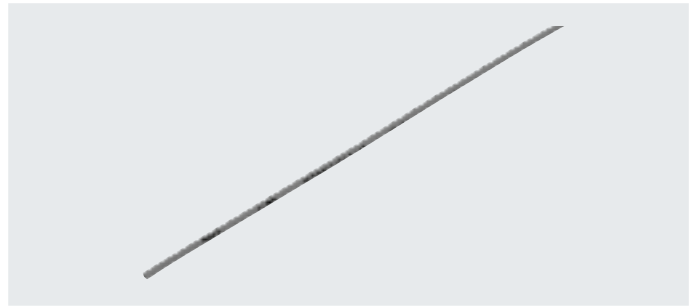

Operating and environmental conditions	
Type	PUN-H-2
O.D. [mm]	2
Pneumatic connection	
For push-in connector [mm]	2
Temperature-dependent operating pressure [bar]	-0.95 ... +10 → graph
Operating medium	Compressed air to ISO 8573-1:2010 [7:-:-]
Ambient temperature [°C]	-35 ... +60
Tubing characteristics	Suitable for energy chains in applications with high cycle rates
Tubing test conditions	Suitable for energy chains: > 5 million cycles to Festo standard 942021

Operating pressure p as a function of temperature t

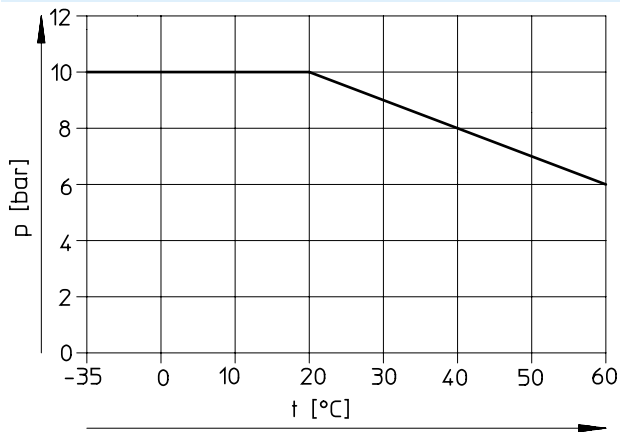

Materials

Shore hardness	D 52 ±3
Tubing	TPE-U(PU)
Note on materials	RoHS-compliant
	Free of copper and PTFE

Dimensions and ordering data

O.D.	I.D.	Min. bending radius	Flow-relevant bending radius	Weight	Colour	Part no.	Type	PU ¹⁾
[mm]	[mm]	[mm]	[mm]	[kg/m]				[m]
2	1.2	5	8	0.0024	Natural	133038	PUN-H-2x0.4-NT	50
					Black	133039	PUN-H-2x0.4-SW	50
					Red	133040	PUN-H-2x0.4-RT	50

1) Packaging unit

Datasheet

Plastic tubing PUN-H

With O.D. 3 ... 16 mm



Operating and environmental conditions									
Type		PUN-H-3	PUN-H-4	PUN-H-6	PUN-H-8	PUN-H-10	PUN-H-12	PUN-H-14	PUN-H-16
O.D.	[mm]	3	4	6	8	10	12	14	16
Pneumatic connection									
	For push-in connector [mm]	3	4	6	8	10	12	14	16
	For barbed connector with union nut [mm]	-	3	4	6	-	-	-	-
Temperature-dependent operating pressure	[bar]	-0.95 ... +10 → graph							
Operating medium		Compressed air to ISO 8573-1:2010 [7:-:-] Water as per manufacturer's declaration ¹⁾							
PWIS conformity		VDMA24364-B2-L							
Ambient temperature	[°C]	-35 ... +60							
Food-safe ¹⁾		See supplementary material information							
Material fire test		UL94 HB							
Certification ¹⁾		German Technical Control Board (TÜV)							
Certificate-issuing authority		B 013277 0506 00							
Tubing characteristics		Suitable for energy chains in applications with high cycle rates							
Tubing test conditions		Suitable for energy chains: > 5 million cycles to Festo standard 942021							

1) Only for the colours natural, blue, black, silver, red, green, yellow
Additional information: www.festo.com/catalogue/pun-h → Support/Downloads.

Operating pressure p as a function of temperature t

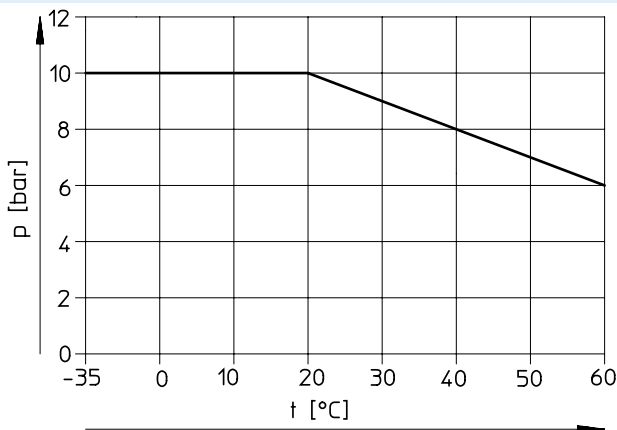

Materials	
Shore hardness	D 52 ±3
Tubing	TPE-U(PU)
Note on materials	RoHS-compliant Free of copper and PTFE

Datasheet

Dimensions – Reel

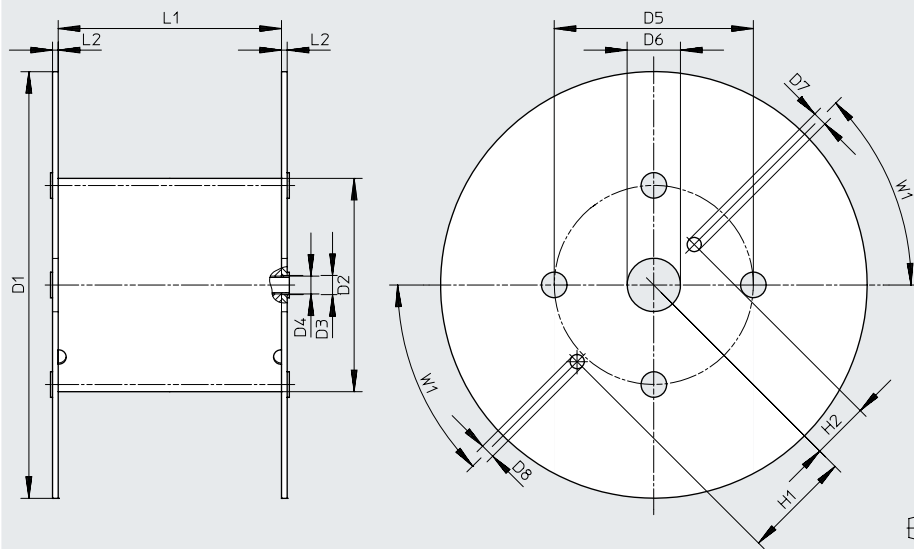

Type	D1 ø	D2 ø	D3 ø	D4 ø	D5 ø	D6 ø	D7 ø	D8 ø	H1	H2	L1	L2	W1
For PUN-H-3x0.5-...-500	545	246	21	20	216	75	20	20	152.5	80.5	128	8	45°
For PUN-H-4x0.75-...-500	545	246	21	20	216	75	20	20	152.5	80.5	128	8	45°
For PUN-H-6x1-...-500	545	246	21	20	216	75	20	20	152.5	80.5	128	8	45°
For PUN-H-8x1.25-...-400	545	310	21	20	280	75	20	20	152.5	80.5	254	8	45°
For PUN-H-10x1.5-...-300	600	310	21	20	280	75	20	20	152.5	80.5	254	8	45°
For PUN-H-12x2-...-200	600	310	21	20	280	75	20	20	152.5	80.5	254	8	45°
For PUN-H-16x2.5-...-100	545	310	21	20	280	75	20	20	152.5	80.5	254	8	45°

Dimensions and ordering data

O.D. [mm]	I.D. [mm]	Min. bending radius [mm]	Flow-relevant bending radius [mm]	Weight [kg/m]	Colour	Part no.	Type	PJ ¹⁾ [m]
3	2.1	6	12	0.0042	Natural	197375	PUN-H-3x0.5-NT	50
					Natural	558263	PUN-H-3x0.5-NT-500	500
					Blue	197382	PUN-H-3x0.5-BL	50
					Blue	558256	PUN-H-3x0.5-BL-500	500
					Black	197389	PUN-H-3x0.5-SW	50
					Black	558249	PUN-H-3x0.5-SW-500	500
					Silver	558277	PUN-H-3x0.5-SI	50
					Silver	558270	PUN-H-3x0.5-SI-500	500
					Red	558284	PUN-H-3x0.5-RT	50
					Green	558291	PUN-H-3x0.5-GN	50
Yellow	558298	PUN-H-3x0.5-GE	50					

1) Packaging unit

Datasheet

Dimensions and ordering data								
O.D.	I.D.	Min. bending radius	Flow-relevant bending radius	Weight	Colour	Part no.	Type	PJ ¹⁾
[mm]	[mm]	[mm]	[mm]	[kg/m]				[m]
4	2.6	8	16	0.0085	Natural	★ 197376	PUN-H-4x0.75-NT	50
					Natural	★ 558264	PUN-H-4x0.75-NT-500	500
					Blue	★ 197383	PUN-H-4x0.75-BL	50
					Blue	★ 558257	PUN-H-4x0.75-BL-500	500
					Translucent blue	★ 8048671	PUN-H-4x0.75-TBL	50
					Translucent blue	★ 8048672	PUN-H-4x0.75-TBL-500	500
					Black	★ 197390	PUN-H-4x0.75-SW	50
					Black	★ 558250	PUN-H-4x0.75-SW-500	500
					Translucent black	★ 8048673	PUN-H-4x0.75-TSW	50
					Translucent black	★ 8048674	PUN-H-4x0.75-TSW-500	500
					Silver	★ 558278	PUN-H-4x0.75-SI	50
					Silver	★ 558271	PUN-H-4x0.75-SI-500	500
					Red	558285	PUN-H-4x0.75-RT	50
					Translucent red	8048675	PUN-H-4x0.75-TRT	50
					Translucent red	8048676	PUN-H-4x0.75-TRT-500	500
					Green	558292	PUN-H-4x0.75-GN	50
					Translucent green	8048677	PUN-H-4x0.75-TGN	50
					Translucent green	8048678	PUN-H-4x0.75-TGN-500	500
					Yellow	558299	PUN-H-4x0.75-GE	50
					Translucent yellow	8048679	PUN-H-4x0.75-TGE	50
Translucent yellow	8048680	PUN-H-4x0.75-TGE-500	500					
6	4	10	26	0.0183	Natural	★ 197377	PUN-H-6x1-NT	50
					Natural	★ 558265	PUN-H-6x1-NT-500	500
					Blue	★ 197384	PUN-H-6x1-BL	50
					Blue	★ 558258	PUN-H-6x1-BL-500	500
					Translucent blue	★ 8048681	PUN-H-6x1-TBL	50
					Translucent blue	★ 8048682	PUN-H-6x1-TBL-500	500
					Black	★ 197391	PUN-H-6x1-SW	50
					Black	★ 558251	PUN-H-6x1-SW-500	500
					Translucent black	★ 8048683	PUN-H-6x1-TSW	50
					Translucent black	★ 8048684	PUN-H-6x1-TSW-500	500
					Silver	★ 558279	PUN-H-6x1-SI	50
					Silver	★ 558272	PUN-H-6x1-SI-500	500
					Red	558286	PUN-H-6x1-RT	50
					Translucent red	8048685	PUN-H-6x1-TRT	50
					Translucent red	8048686	PUN-H-6x1-TRT-500	500
					Green	558293	PUN-H-6x1-GN	50
					Translucent green	8048687	PUN-H-6x1-TGN	50
					Translucent green	8048688	PUN-H-6x1-TGN-500	500
					Yellow	558300	PUN-H-6x1-GE	50
					Translucent yellow	8048689	PUN-H-6x1-TGE	50
Translucent yellow	8048690	PUN-H-6x1-TGE-500	500					

1) Packaging unit

Datasheet

Dimensions and ordering data													
O.D.	I.D.	Min. bending radius	Flow-relevant bending radius	Weight	Colour	Part no.	Type	PU ¹⁾					
[mm]	[mm]	[mm]	[mm]	[kg/m]				[m]					
8	5.7	21	37	0.0287	Natural	★ 197378	PUN-H-8x1.25-NT	1 ... 50					
					Natural	★ 558266	PUN-H-8x1.25-NT-400	400					
					Blue	★ 197385	PUN-H-8x1.25-BL	1 ... 50					
					Blue	★ 558259	PUN-H-8x1.25-BL-400	400					
					Translucent blue	★ 8048691	PUN-H-8x1.25-TBL	50					
					Translucent blue	★ 8048692	PUN-H-8x1.25-TBL-400	400					
					Black	★ 197392	PUN-H-8x1.25-SW	1 ... 50					
					Black	★ 558252	PUN-H-8x1.25-SW-400	400					
					Translucent black	★ 8048693	PUN-H-8x1.25-TSW	50					
					Translucent black	★ 8048694	PUN-H-8x1.25-TSW-400	400					
					Silver	★ 558280	PUN-H-8x1.25-SI	1 ... 50					
					Silver	★ 558273	PUN-H-8x1.25-SI-400	400					
					Red	558287	PUN-H-8x1.25-RT	1 ... 50					
					Translucent red	8048695	PUN-H-8x1.25-TRT	50					
					Translucent red	8048696	PUN-H-8x1.25-TRT-400	400					
					Green	558294	PUN-H-8x1.25-GN	1 ... 50					
					Translucent green	8048697	PUN-H-8x1.25-TGN	50					
					Translucent green	8048698	PUN-H-8x1.25-TGN-400	400					
					Yellow	558301	PUN-H-8x1.25-GE	1 ... 50					
					Translucent yellow	8048699	PUN-H-8x1.25-TGE	50					
					Translucent yellow	8048700	PUN-H-8x1.25-TGE-400	400					
					10	7	28	52	0.0465	Natural	★ 197379	PUN-H-10x1.5-NT	1 ... 50
										Natural	★ 558267	PUN-H-10x1.5-NT-300	300
Blue	★ 197386	PUN-H-10x1.5-BL	1 ... 50										
Blue	★ 558260	PUN-H-10x1.5-BL-300	300										
Translucent blue	★ 8048701	PUN-H-10x1.5-TBL	50										
Translucent blue	★ 8048702	PUN-H-10x1.5-TBL-300	300										
Black	★ 197393	PUN-H-10x1.5-SW	1 ... 50										
Black	★ 558253	PUN-H-10x1.5-SW-300	300										
Translucent black	★ 8048703	PUN-H-10x1.5-TSW	50										
Translucent black	★ 8048704	PUN-H-10x1.5-TSW-300	300										
Silver	★ 558281	PUN-H-10x1.5-SI	1 ... 50										
Silver	★ 558274	PUN-H-10x1.5-SI-300	300										
Red	558288	PUN-H-10x1.5-RT	1 ... 50										
Translucent red	8048705	PUN-H-10x1.5-TRT	50										
Translucent red	8048706	PUN-H-10x1.5-TRT-300	300										
Green	558295	PUN-H-10x1.5-GN	1 ... 50										
Translucent green	8048707	PUN-H-10x1.5-TGN	50										
Translucent green	8048708	PUN-H-10x1.5-TGN-300	300										
Yellow	558302	PUN-H-10x1.5-GE	1 ... 50										
Translucent yellow	8048709	PUN-H-10x1.5-TGE	50										
Translucent yellow	8048710	PUN-H-10x1.5-TGE-300	300										

1) Packaging unit
Can only be ordered by the metre.

Datasheet

Dimensions and ordering data								
O.D.	I.D.	Min. bending radius	Flow-relevant bending radius	Weight	Colour	Part no.	Type	PJ ¹⁾
[mm]	[mm]	[mm]	[mm]	[kg/m]				[m]
12	8	33	62	0.0729	Natural	★ 197380	PUN-H-12x2-NT	1 ... 50
					Natural	★ 558268	PUN-H-12x2-NT-200	200
					Blue	★ 197387	PUN-H-12x2-BL	1 ... 50
					Blue	★ 558261	PUN-H-12x2-BL-200	200
					Translucent blue	★ 8048711	PUN-H-12x2-TBL	50
					Translucent blue	★ 8048712	PUN-H-12x2-TBL-200	200
					Black	★ 197394	PUN-H-12x2-SW	1 ... 50
					Black	★ 558254	PUN-H-12x2-SW-200	200
					Translucent black	★ 8048713	PUN-H-12x2-TSW	50
					Translucent black	★ 8048714	PUN-H-12x2-TSW-200	200
					Silver	★ 558282	PUN-H-12x2-SI	1 ... 50
					Silver	★ 558275	PUN-H-12x2-SI-200	200
					Red	558289	PUN-H-12x2-RT	1 ... 50
					Translucent red	8048715	PUN-H-12x2-TRT	50
					Translucent red	8048716	PUN-H-12x2-TRT-200	200
					Green	558296	PUN-H-12x2-GN	1 ... 50
					Translucent green	8048717	PUN-H-12x2-TGN	50
					Translucent green	8048718	PUN-H-12x2-TGN-200	200
					Yellow	558303	PUN-H-12x2-GE	1 ... 50
					Translucent yellow	8048719	PUN-H-12x2-TGE	50
Translucent yellow	8048720	PUN-H-12x2-TGE-200	200					
14	9.8	38	78	0.091	Natural	570388	PUN-H-14x2-NT	1 ... 50
					Blue	570386	PUN-H-14x2-BL	1 ... 50
					Black	570387	PUN-H-14x2-SW	1 ... 50
16	11	38	88	0.123	Natural	197381	PUN-H-16x2.5-NT	1 ... 50
					Natural	558269	PUN-H-16x2.5-NT-100	100
					Blue	197388	PUN-H-16x2.5-BL	1 ... 50
					Blue	558262	PUN-H-16x2.5-BL-100	100
					Black	197395	PUN-H-16x2.5-SW	1 ... 50
					Black	558255	PUN-H-16x2.5-SW-100	100
					Silver	558283	PUN-H-16x2.5-SI	1 ... 50
					Silver	558276	PUN-H-16x2.5-SI-100	100
					Red	558290	PUN-H-16x2.5-RT	1 ... 50
					Green	558297	PUN-H-16x2.5-GN	1 ... 50
Yellow	558304	PUN-H-16x2.5-GE	1 ... 50					

1) Packaging unit
Can only be ordered by the metre.

Datasheet

DUO tubing PUN-H-DUO

Highly flexible paired plastic tubing characterised by great resistance to abrasion and kinks.

Two lengths of tubing are fused together into a tubing pair. For fitting, the paired tubing is separated as required at both ends.

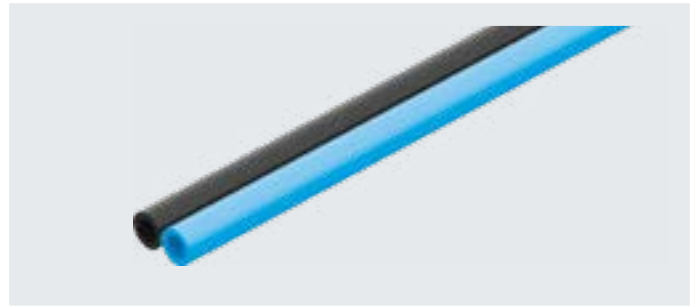

Operating and environmental conditions					
Type		PUN-H-4-...-DUO	PUN-H-6-...-DUO	PUN-H-8-...-DUO	PUN-H-10-...-DUO
O.D.	[mm]	4	6	8	10
Pneumatic connection					
	For push-in connector [mm]	4	6	8	10
	For barbed connector with union nut [mm]	3	4	6	–
Temperature-dependent operating pressure	[bar]	–0.95 ... +10 → graph			
Operating medium		Compressed air to ISO 8573-1:2010 [7:--–]			
		Water as per manufacturer's declaration ¹⁾			
PWIS conformity		VDMA24364-B2-L			
Ambient temperature	[°C]	–35 ... +60			
Food-safe ¹⁾		See supplementary material information			
Material fire test		UL94 HB			
Certification ¹⁾		German Technical Control Board (TÜV)			
Certificate-issuing authority		B 013277 0506 00			
Tubing characteristics		Suitable for energy chains in applications with high cycle rates			
Tubing test conditions		Suitable for energy chains: > 5 million cycles to Festo standard 942021			

1) Additional information: www.festo.com/catalogue/pun-h → Support/Downloads.

Operating pressure p as a function of temperature t

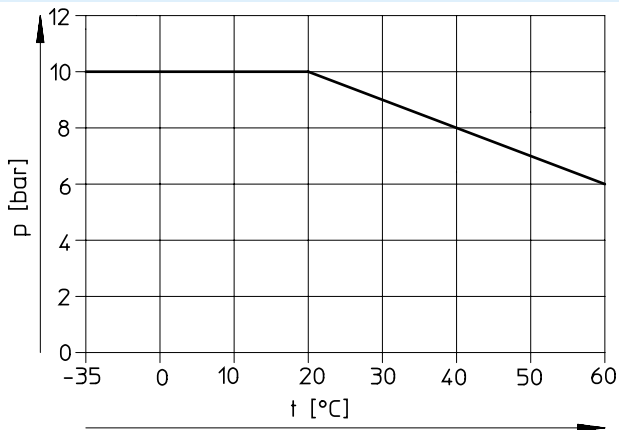

Materials	
Shore hardness	D 52 ±3
Tubing	TPE-U(PU)
Note on materials	RoHS-compliant
	Free of copper and PTFE

Datasheet

Dimensions and ordering data								
O.D.	I.D.	Min. bending radius	Flow-relevant bending radius	Weight	Colour	Part no.	Type	PJ ¹⁾
[mm]	[mm]	[mm]	[mm]	[kg/m]				[m]
4	2.6	8	16	0.017	Blue/black	197396	PUN-H-4x0.75-DUO	50
6	4	10	26	0.0366		197397	PUN-H-6x1-DUO	50
8	5.7	21	37	0.0574		197398	PUN-H-8x1.25-DUO	1 ... 50
10	7	28	52	0.093		197399	PUN-H-10x1.5-DUO	1 ... 50

1) Packaging unit
Can only be ordered by the metre.

Datasheet

Plastic tubing PUN-H-F

With O.D. 4 ... 16 mm

Suitable for contact with food.

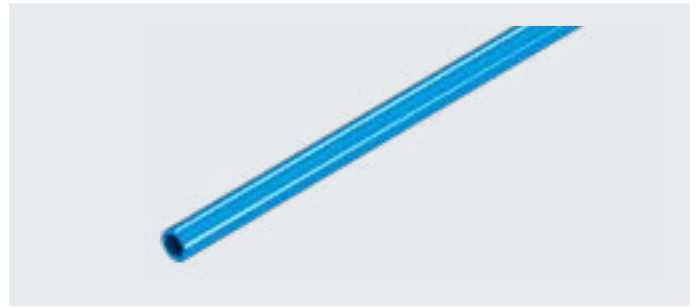

Operating and environmental conditions							
Type	PUN-H-F-4	PUN-H-F-6	PUN-H-F-8	PUN-H-F-10	PUN-H-F-12	PUN-H-F-14	PUN-H-F-16
O.D. [mm]	4	6	8	10	12	14	16
Pneumatic connection							
For push-in connector [mm]	4	6	8	10	12	14	16
For barbed connector with union nut [mm]	3	4	6	10	–	–	–
Temperature-dependent operating pressure	–0.095 ... 1 MPa						
	–0.95 ... 10 bar						
	–13.775 ... 145 psi						
Operating pressure for full temperature range	–0.095 ... 0.6 MPa						
	–0.95 ... 6 bar						
	–13.775 ... 87 psi						
Note on operating pressure	Water: max. 0.65 MPa at 20°C, max. 0.45 MPa at 40°C, max. 0.3 MPa at 60°C						
Operating medium	Compressed air to ISO 8573-1:2010 [7:-:-]						
	Water (liquid, ice-free) ¹⁾						
	Oxygen ²⁾						
PWIS conformity	VDMA24364-B2-L						
Food-safe	See declaration of conformity ¹⁾						
Ambient temperature [°C]	–35 ... 60						
Material fire test	UL94 HB						
Tubing characteristics	Suitable for energy chains						

1) Additional information: www.festo.com/catalogue/pun-h-f → Support/Downloads.

2) Applies to NT variants only (colour: natural).

Operating pressure p as a function of temperature t

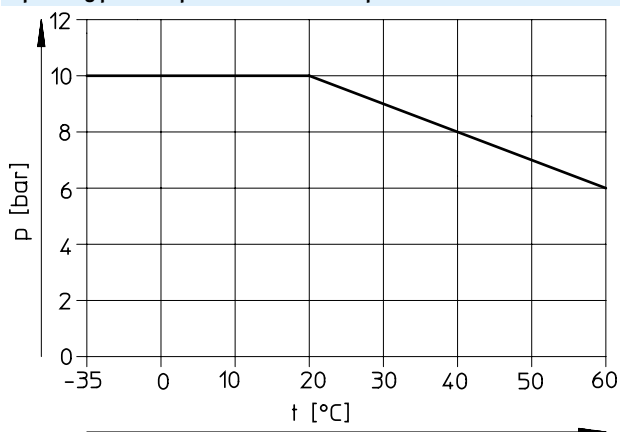

Materials

Shore hardness	D 52 ±3
Material of tubing	TPE-U(PU)
Application note	TPE-U, ether-based
	Tubing without printing
Note on materials	RoHS-compliant

Datasheet

Dimensions and ordering data								
O.D.	I.D.	Min. bending radius	Flow-relevant bending radius	Weight	Colour	Part no.	Type	PJ ¹⁾
[mm]	[mm]	[mm]	[mm]	[kg/m]				[m]
4	2.6	8	16	0.0084	Natural	8153378	PUN-H-F-4X0.75-NT	50
					Red	8153379	PUN-H-F-4X0.75-RT	50
					Blue	8153381	PUN-H-F-4X0.75-BL	50
					Translucent blue	8153382	PUN-H-F-4X0.75-TBL	50
					Green	8153383	PUN-H-F-4X0.75-GN	50
					Yellow	8153384	PUN-H-F-4X0.75-GE	50
					Black	8153385	PUN-H-F-4X0.75-SW	50
6	4	10	26	0.0181	Natural	8153428	PUN-H-F-6X1-NT	50
					Red	8153386	PUN-H-F-6X1-RT	50
					Blue	8153388	PUN-H-F-6X1-BL	50
					Translucent blue	8153389	PUN-H-F-6X1-TBL	50
					Green	8153390	PUN-H-F-6X1-GN	50
					Yellow	8153391	PUN-H-F-6X1-GE	50
					Black	8153392	PUN-H-F-6X1-SW	50
8	5.7	21	37	0.0285	Natural	8153429	PUN-H-F-8X1.25-NT	50
					Red	8153393	PUN-H-F-8X1.25-RT	50
					Blue	8153395	PUN-H-F-8X1.25-BL	50
					Translucent blue	8153396	PUN-H-F-8X1.25-TBL	50
					Green	8153397	PUN-H-F-8X1.25-GN	50
					Yellow	8153398	PUN-H-F-8X1.25-GE	50
					Black	8153399	PUN-H-F-8X1.25-SW	50
10	7	28	52	0.0461	Natural	8153430	PUN-H-F-10X1.5-NT	50
					Red	8153400	PUN-H-F-10X1.5-RT	50
					Blue	8153402	PUN-H-F-10X1.5-BL	50
					Translucent blue	8153403	PUN-H-F-10X1.5-TBL	50
					Green	8153404	PUN-H-F-10X1.5-GN	50
					Yellow	8153405	PUN-H-F-10X1.5-GE	50
					Black	8153406	PUN-H-F-10X1.5-SW	50
12	8	33	62	0.0723	Natural	8153407	PUN-H-F-12X2-NT	50
					Red	8153408	PUN-H-F-12X2-RT	50
					Blue	8153410	PUN-H-F-12X2-BL	50
					Translucent blue	8153411	PUN-H-F-12X2-TBL	50
					Green	8153412	PUN-H-F-12X2-GN	50
					Yellow	8153413	PUN-H-F-12X2-GE	50
					Black	8153414	PUN-H-F-12X2-SW	50
14	9.8	38	78	0.0911	Natural	8153415	PUN-H-F-14X2-NT	50
					Red	8153416	PUN-H-F-14X2-RT	50
					Blue	8153417	PUN-H-F-14X2-BL	50
					Black	8153418	PUN-H-F-14X2-SW	50
16	11	38	88	0.122	Natural	8153419	PUN-H-F-16X2.5-NT	50
					Red	8153420	PUN-H-F-16X2.5-RT	50
					Blue	8153422	PUN-H-F-16X2.5-BL	50
					Translucent blue	8153423	PUN-H-F-16X2.5-TBL	50
					Green	8153424	PUN-H-F-16X2.5-GN	50
					Yellow	8153425	PUN-H-F-16X2.5-GE	50
					Black	8153426	PUN-H-F-16X2.5-SW	50

1) Packaging unit

Datasheet

Plastic tubing PUN-V0

Highly flexible single-sheath plastic tubing, flame-retardant

For use in the close vicinity of welding applications

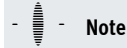

Note

As this tubing is flame retardant, the colours differ from the standard colours.

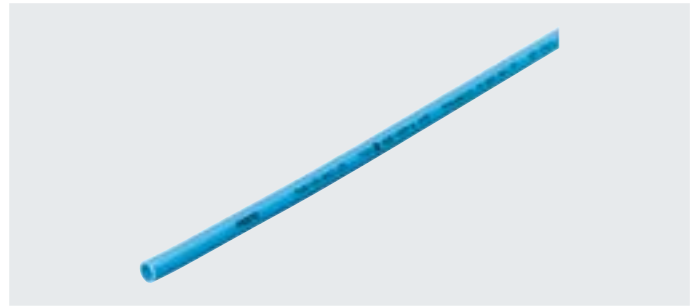

Operating and environmental conditions					
Type		PUN-V0-6	PUN-V0-8	PUN-V0-10	PUN-V0-16
O.D.	[mm]	6	8	10	16
Pneumatic connection					
	For push-in connector [mm]	6	8	10	16
	For barbed connector [mm]	4	6	–	–
	For barbed connector with union nut [mm]	4	6	–	–
Temperature-dependent operating pressure	[bar]	–0.95 ... +10 → graph			
Operating medium		Compressed air to ISO 8573-1:2010 [7:--:–] Water as per manufacturer's declaration ¹⁾			
PWIS conformity		VDMA24364-B2-L			
Ambient temperature	[°C]	–35 ... +60			
Material fire test		UL94 V-0 (for test specimen 3 mm thick) UL94 V-2 (for test specimen 0.75 mm thick)			
Certification		German Technical Control Board (TÜV)			
Certificate-issuing authority		B 013277 0506 00			
Tubing characteristics		Suitable for energy chains in applications with high cycle rates			
Tubing test conditions		Suitable for energy chains: > 5 million cycles to Festo standard 942021			

1) Additional information: www.festo.com/catalogue/pun-v0 → Support/Downloads.

Operating pressure p as a function of temperature t

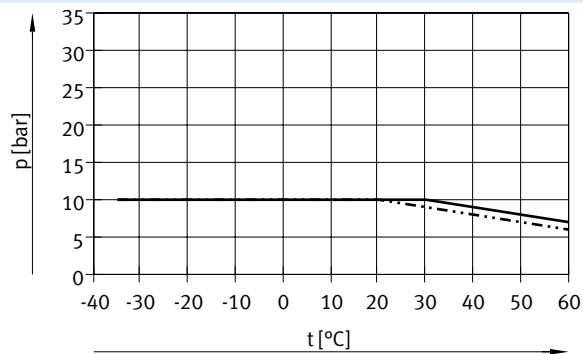

— PUN-V0-6/8/10
 - - - - PUN-V0-16

Datasheet

Materials								
Shore hardness		D 54 ±3						
Tubing		TPE-U(PU)						
Note on materials		RoHS-compliant						
		Free of copper and PTFE						
Dimensions and ordering data								
O.D.	I.D.	Min. bending radius	Flow-relevant bending radius	Weight	Colour	Part no.	Type	PU ¹⁾
[mm]	[mm]	[mm]	[mm]	[kg/m]				[m]
6	4	12	26.5	0.02	Black	525438	PUN-V0-6x1-SW	1 ... 50
					Blue	525442	PUN-V0-6x1-BL	1 ... 50
					Green	525446	PUN-V0-6x1-GN	1 ... 50
					Red	525450	PUN-V0-6x1-RT	1 ... 50
					White	525454	PUN-V0-6x1-WS	1 ... 50
					Yellow	525458	PUN-V0-6x1-GE	1 ... 50
					Brown	525462	PUN-V0-6x1-BR	1 ... 50
8	5.7	18	37	0.031	Black	525439	PUN-V0-8x1.25-SW	1 ... 50
					Blue	525443	PUN-V0-8x1.25-BL	1 ... 50
					Green	525447	PUN-V0-8x1.25-GN	1 ... 50
					Red	525451	PUN-V0-8x1.25-RT	1 ... 50
					White	525455	PUN-V0-8x1.25-WS	1 ... 50
					Yellow	525459	PUN-V0-8x1.25-GE	1 ... 50
					Brown	525463	PUN-V0-8x1.25-BR	1 ... 50
10	7	20	54	0.051	Black	525440	PUN-V0-10x1.5-SW	1 ... 50
					Blue	525444	PUN-V0-10x1.5-BL	1 ... 50
					Green	525448	PUN-V0-10x1.5-GN	1 ... 50
					Red	525452	PUN-V0-10x1.5-RT	1 ... 50
					White	525456	PUN-V0-10x1.5-WS	1 ... 50
					Yellow	525460	PUN-V0-10x1.5-GE	1 ... 50
					Brown	525464	PUN-V0-10x1.5-BR	1 ... 50
16	11.8	50	90	0.122	Black	570767	PUN-V0-16x2-SW	1 ... 50
					Blue	570768	PUN-V0-16x2-BL	1 ... 50

1) Packaging unit
Can only be ordered by the metre.

Datasheet

Plastic tubing PUN-V0-C

Highly flexible single-sheath plastic tubing, flame-retardant

For use in the immediate vicinity of welding applications.

Note

As this tubing is flame retardant, the colours differ from the standard colours.

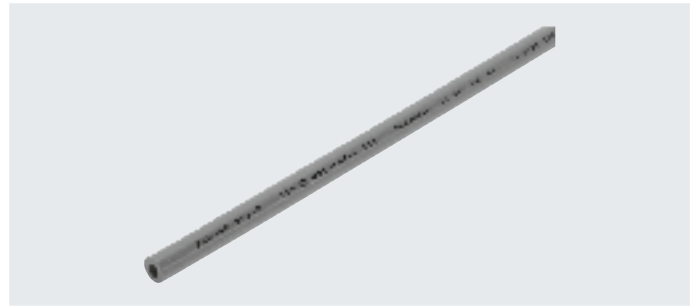

Operating and environmental conditions

Type	PUN-V0-4...-C	PUN-V0-6...-C	PUN-V0-8...-C	PUN-V0-10...-C	PUN-V0-12...-C	PUN-V0-14...-C	PUN-V0-16...-C
O.D. [mm]	4	6	8	10	12	14	16
Pneumatic connection							
For push-in connector [mm]	4	6	8	10	12	14	16
For barbed connector [mm]	–	2	4	6	–	–	–
Temperature-dependent operating pressure [bar]	–0.95 ... +10 → graph	–0.95 ... +30 ¹⁾ → graph	–0.95 ... +20 ¹⁾ → graph	–0.95 ... +16 ¹⁾ → graph	–0.95 ... +10 → graph	–0.95 ... +9 → graph	–0.95 ... +10 → graph
Operating medium	Compressed air to ISO 8573-1:2010 [7:--:–] Water as per manufacturer's declaration ²⁾						
PWIS conformity	VDMA24364-B2-L						
Ambient temperature [°C]	–35 ... +60						
Material fire test	UL94 V-0 (for test specimen 3 mm thick) UL94 V-2 (for test specimen 0.75 mm thick)						
Certification ²⁾	German Technical Control Board (TÜV)						
Certificate-issuing authority	B 013277 0506 00						
Tubing characteristics	Suitable for energy chains in applications with high cycle rates						
Tubing test conditions	Suitable for energy chains: > 5 million cycles to Festo standard 942021						

1) Limited to 10 bar for applications involving welding spatter.

2) Additional information: www.festo.com/catalogue/pun-v0-c → Support/Downloads.

Operating pressure p as a function of temperature t

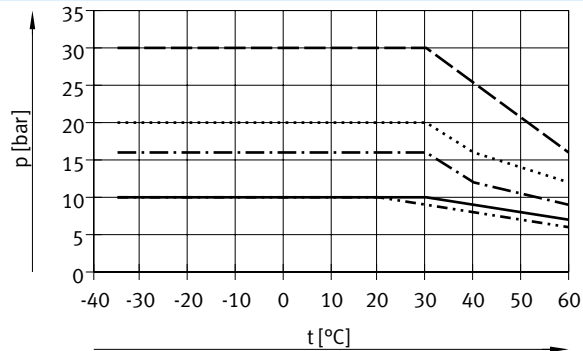

— PUN-V0-4...-C
- - - PUN-V0-14x2...-C

For applications without welding spatter

— — — PUN-V0-6x2...-C
..... PUN-V0-8x2...-C
- · - · - PUN-V0-10x2...-C

Materials

Shore hardness	D 54 ±3
Tubing	TPE-U(PU)
Note on materials	RoHS-compliant Free of copper and PTFE

Datasheet

Dimensions and ordering data								
O.D.	I.D.	Min. bending radius	Flow-relevant bending radius	Weight	Colour	Part no.	Type	PJ ¹⁾
[mm]	[mm]	[mm]	[mm]	[kg/m]				[m]
4	2	10	20	0.012	Black	570349	PUN-V0-4x1-SW-C	1 ... 50
					Blue	570350	PUN-V0-4x1-BL-C	1 ... 50
6	2	7	24	0.032	Black	561698	PUN-V0-6x2-SW-C	1 ... 50
					Blue	561702	PUN-V0-6x2-BL-C	1 ... 50
					Green	561706	PUN-V0-6x2-GN-C	1 ... 50
					Red	561710	PUN-V0-6x2-RT-C	1 ... 50
					White	561714	PUN-V0-6x2-WS-C	1 ... 50
					Yellow	561718	PUN-V0-6x2-GE-C	1 ... 50
					Brown	561722	PUN-V0-6x2-BR-C	1 ... 50
8	4	9	35	0.049	Black	561699	PUN-V0-8x2-SW-C	1 ... 50
					Blue	561703	PUN-V0-8x2-BL-C	1 ... 50
					Green	561707	PUN-V0-8x2-GN-C	1 ... 50
					Red	561711	PUN-V0-8x2-RT-C	1 ... 50
					White	561715	PUN-V0-8x2-WS-C	1 ... 50
					Yellow	561719	PUN-V0-8x2-GE-C	1 ... 50
					Brown	561723	PUN-V0-8x2-BR-C	1 ... 50
10	6	12	42	0.064	Black	561700	PUN-V0-10x2-SW-C	1 ... 50
					Blue	561704	PUN-V0-10x2-BL-C	1 ... 50
					Green	561708	PUN-V0-10x2-GN-C	1 ... 50
					Red	561712	PUN-V0-10x2-RT-C	1 ... 50
					White	561716	PUN-V0-10x2-WS-C	1 ... 50
					Yellow	561720	PUN-V0-10x2-GE-C	1 ... 50
					Brown	561724	PUN-V0-10x2-BR-C	1 ... 50
12	8	19	55	0.08	Black	561701	PUN-V0-12x2-SW-C	1 ... 50
					Blue	561705	PUN-V0-12x2-BL-C	1 ... 50
					Green	561709	PUN-V0-12x2-GN-C	1 ... 50
					Red	561713	PUN-V0-12x2-RT-C	1 ... 50
					White	561717	PUN-V0-12x2-WS-C	1 ... 50
					Yellow	561721	PUN-V0-12x2-GE-C	1 ... 50
					Brown	561725	PUN-V0-12x2-BR-C	1 ... 50
14	9.8	45	70	0.096	Black	570351	PUN-V0-14x2-SW-C	1 ... 50
					Blue	570352	PUN-V0-14x2-BL-C	1 ... 50
16	11	50	90	0.147	Black	570353	PUN-V0-16x2.5-SW-C	1 ... 50
					Blue	570354	PUN-V0-16x2.5-BL-C	1 ... 50

1) Packaging unit
Can only be ordered by the metre.

Ordering data – Modular product system

Ordering table (minimum order quantity 3000 m with tubing O.D. ≤ 8 mm, 1500 m with tubing O.D. > 8 mm, rounded value 25 m)											
Size	3	4	6	8	10	12	14	16	Conditions	Code	Enter code
Module no.	553573										
Function	Polyurethane tubing, standard O.D.										PUN
Alternative material characteristic	Standard										
	Hydrolysis resistant										-H
	-	Antistatic						-			-CM
	-	-	Flame-retardant			-	-				-VO
	-	Resistant to welding spatter									
Tubing O.D. [mm]	3	-	-	-	-	-	-	-			-3
	-	4	-	-	-	-	-	-			-4
	-	-	6	-	-	-	-	-			-6
	-	-	-	8	-	-	-	-			-8
	-	-	-	-	10	-	-	-			-10
	-	-	-	-	-	12	-	-			-12
	-	-	-	-	-	-	14	-			-14
	-	-	-	-	-	-	-	16			-16
Colour	Silver									[1] [2]	-SI
	Blue									[1] [3]	-BL
	Translucent blue									[4]	-TBL
	Black									[3]	-SW
	Translucent black									[4]	-TSW
	Yellow									[1]	-GE
	Translucent yellow									[4]	-TGE
	Green									[1]	-GN
	Translucent green									[4]	-TGN
	Red									[1]	-RT
	Translucent red									[4]	-TRT
	Brown									[1]	-BR
	White									[1]	-WS
	Natural									[1] [3] [4]	-NT
Labelling text (on request)	Standard										
	Customer-specific tubing inscription									[5]	-TXT
Packaging unit [m]	25										-25
	50										-50
	100										-100
	200						-	-			-200
	300					-	-	-			-300
	400				-	-	-	-			-400
	500			-	-	-	-	-			-500
Packaging	Cardboard box									[6]	-CB
	Reel									[7]	-HA

[1] SI, BL, GE, GN, RT, Not with alternative material characteristic CM
BR, WS, NT

[2] SI Not with alternative material characteristic VO, VOCCO

[3] BL, SW, NT In combination with alternative material characteristic H: food-safe

[4] TBL, TSW, TGE, Only with alternative material characteristic H
TGN, TRT, NT

[5] TXT Not in the Online Shop.

[6] CB Festo logo, order code, TÜV, operating pressure, dimensions omitted

[7] HA Only with packaging unit 25, 50

[7] HA Not with packaging unit 25, 50

Not with alternative material characteristic VO, VOC, CM